

PRICE LIST



10678 Jones Rd. Houston, TX 77065

Phone: 281-469-9996, Fax: 281-469-9997

Website: www.annasdrapery.com, Email: sales@annasdrapery.com



Table of Contents

Page

| | |
|--|----|
| WORKROOM POLICY | 1 |
| ACCESSORIES..... | 2 |
| AWNING, ARCH FRAMES, CANOPY | 3 |
| CORNICE AND SOFT CORNICE | 4 |
| • CORNICE AND SOFT CORNICE - Soft Cornice | 6 |
| CUSHIONS..... | 7 |
| DRAPES (PLEATED & GATHER) | 8 |
| • DRAPES (PLEATED & GATHER) - Pleated Drape | 8 |
| • DRAPES (PLEATED & GATHER) - Tap Top Drape..... | 9 |
| • DRAPES (PLEATED & GATHER) - Gather Drape | 10 |
| • DRAPES (PLEATED & GATHER) - Drape Sheer | 11 |
| • DRAPES (PLEATED & GATHER) - Drape Special Accessories..... | 12 |
| DUST RUFFLE | 13 |
| DUVETS..... | 14 |
| HEAD BOARD..... | 14 |
| LINING | 14 |
| NAPKINS | 14 |
| PLACEMATS | 14 |
| ORDERS WITH STOCK MATERIALS..... | 15 |
| • Buttons..... | 15 |
| • Cover Welt Cord..... | 15 |
| • Make Welt Cord with LIP | 16 |
| • Sew On Gimps | 16 |
| • Twisted or Braided Welt Cord..... | 16 |
| • Velcro | 16 |
| • Anna's Custom Built Unfinished Table..... | 16 |
| • Stuffing..... | 16 |
| PILLOWS | 17 |
| SPECIAL PILLOWS | 20 |
| SHAMS..... | 21 |
| SHADE..... | 22 |
| SUNBURST | 23 |

| | |
|------------------------------|----|
| SWAGS & CASCADES | 24 |
| TABLE SKIRT..... | 28 |
| TABLE RUNNER..... | 29 |
| TIE-BACKS | 30 |
| VALANCE | 31 |
| INSTALLATION PRICE LIST..... | 36 |

WORKROOM POLICY

1. **Half deposit is required for all orders.**
2. NORMAL DELIVERY TIME is two (2) to four (4) weeks AFTER all materials (fabrics and accessories) have been received by our workroom.
3. An additional of 10% surcharge to prices if ANNA IS HELPING to design and calculate yardage.
4. A charge of \$45.00 for any rush orders. If there is more than one order in a side mark, \$35.00 shall be charged to each order after the first one.
5. Our workroom will not be responsible for fabric shortages or flaws.
6. Written instructions must be accompanied with all work orders. Our workroom will not be responsible for more than one change, unless a new set of written instructions is provided.
7. A fine of \$35.00 for EACH RETURNED CHECK.
8. ANNA DRAPERY Inc. will supply all linings. **Customer's linings will not be accepted.**
9. For any special treatment order, customer has to request for a quote before placing the order.
10. If there is an error or mistake made by a designer, there will be a 25% discount on labor. When the mistake is our workroom's fault, the remake is free of charge. **The designer is still responsible for the pickup and installation of the order.**
11. Minimum charge per feet labor is 24"
12. **Designer will be responsible to clip fabric (s) on the order.**
13. **All orders shall be signed by Designer in order to proceed.**
14. \$40.00 Labor charge per hour to repair.

ACCESSORIES

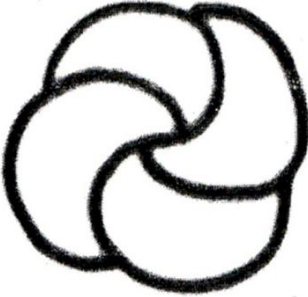
| |
|---|
|  |
| Style: Single Knott |
| Code: KN1 |
| Price: \$9.00 Each |

| |
|--|
|  |
| Style: Double Knott |
| Code: KN2 |
| Price: \$17.50 Each |

| |
|---|
|  |
| Style: Two Color Knott |
| Code: KN3 |
| Price: \$ 17.50 Each |

| |
|---|
|  |
| Style: Rosette |
| Code: RO1 |
| Price: \$17.50 Each |

| |
|---|
|  |
| Style: Two Color Rosette |
| Code: RO2 |
| Price: \$20.50 Each |

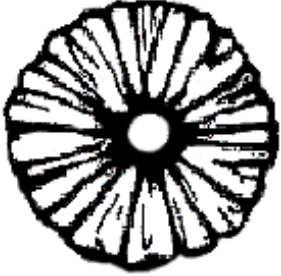
| |
|---|
|  |
| Style: Rosette |
| Code: RO1 |
| Price: \$17.50 Each |

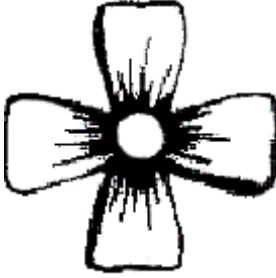
| |
|---|
|  |
| Style: Bow |
| Code: BO1 |
| Price: \$17.50 Each |

| |
|---|
|  |
| Style: Bow |
| Code: BO2 |
| Price: \$17.50 Each |

| |
|---|
|  |
| Style: Soft Knott |
| Code: SN1 |
| Price: \$17.50 Each |

AWNING, ARCH FRAMES, CANOPY

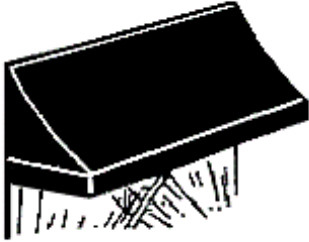
| AWNING | | |
|---|--------------------|----------------|
|  | | |
| Code | Description | Price |
| AW1 | Awning | \$2.75 per in. |

| ARCH FRAME | | |
|-------------------|---------------------------------|---------------|
| Code No. | Description | Price |
| AF1 | Arch Frame up to 35" wide | \$75.50 each |
| AF2 | Arch Frame 36"-47" wide | \$82.50 each |
| AF3 | Arch Frame 48"-59" wide | \$105.00 each |
| AF4 | Arch Frame 60"-72" wide | \$127.50 each |
| AF5 | Arch Frame larger than 73" wide | \$202.00 each |

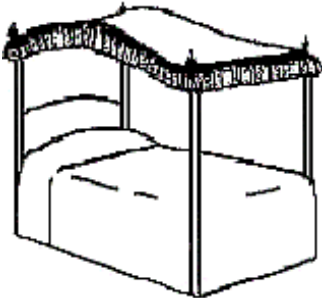
| CANOPY | | |
|---------------|---|---------------|
| Code |  | Price |
| Code | Description | Price |
| CAN1 | Canopy | \$123.50 each |

CORNICE AND SOFT CORNICE

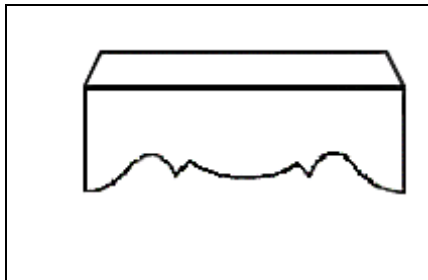

Style: Cornice
Straight or Pattern

Code: CO1

Price: \$3.00 Per In.

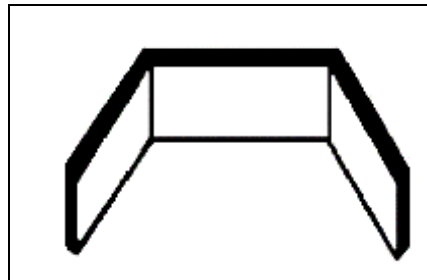

Style: Bay Cornice

Code: CO2

Price: \$3.50 Per In.

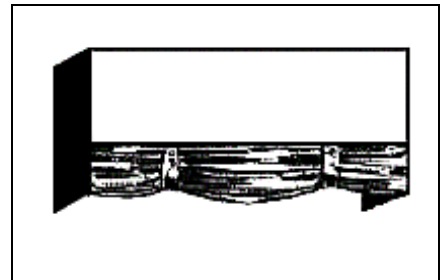

Style: Cornice with
Unique Pleated Bottom

Code: CO3

Price: \$4.75 Per In.

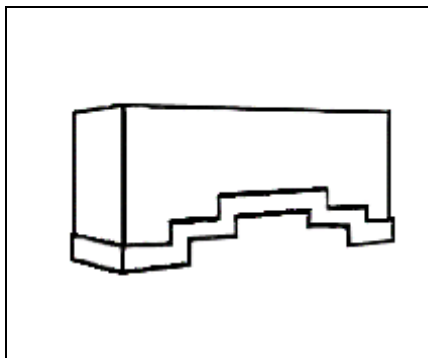

Style: Cornice with
Banding

Code: CO4

Price: \$3.25 Per In.

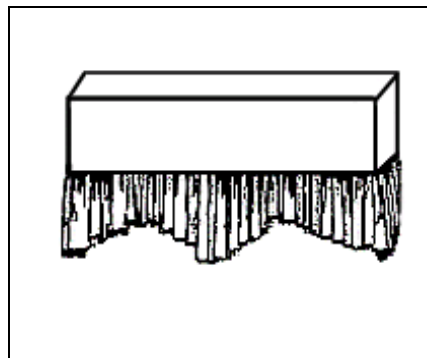

Style: Cornice with
Gather Bottom

Code: CO5

Price: \$4.00 per In.

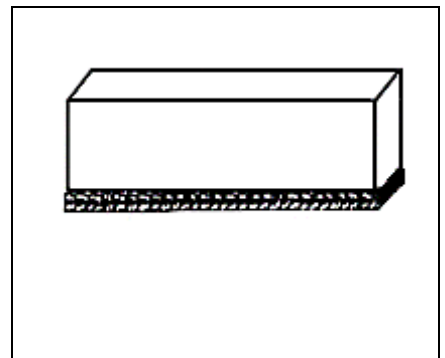

Style: Cornice with
Braided

Code: CO6

Price \$3.50 Per In.

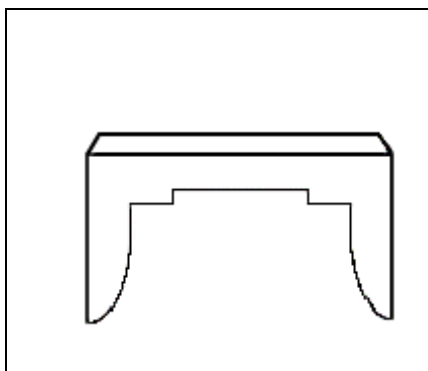

Style: Long Leg Cornice

Code: CO7

Price: \$4.00 Per In.

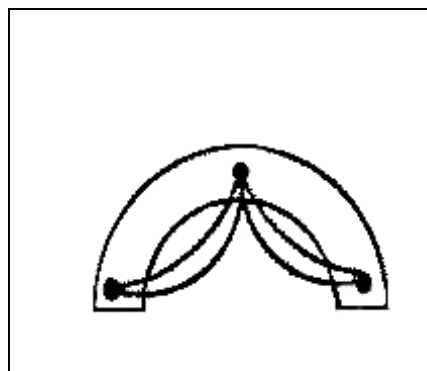

Style: Arch Cornice

Code: CO8

Price: \$4.50 Per In.
Accessories not included

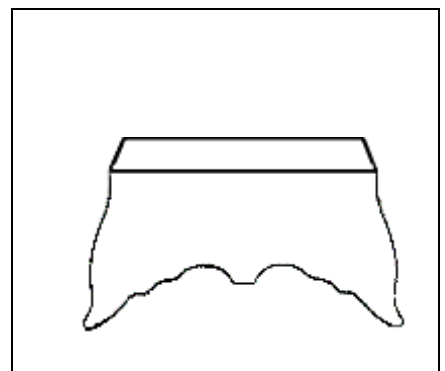

Style: Pagoda

Code: CO9

Price: \$4.00 Per In.

Max FL = 20"

longer than 20" ⇒ \$0.50 extra per in.

CORNICE AND SOFT CORNICE (Continue)



Style: Cornice with Swag Cascade & Rosette

Code:
CO1 - Cornice - \$3.00 /in.
S1 -Swag - \$49.50 /Each
CA1 - Cascade - \$52.00 /pair
RO1 Rosette - \$17.50 each



Style: Juliet

Code: CO 10
Price \$4.25 Per in.

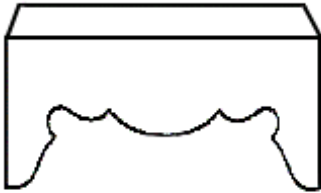

Style: Pembroke

Code: CO12
Price: \$4.00 Per in.

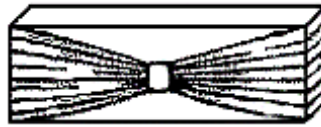

Style: Medallion

Code: CO13
Price: \$4.50 Per in.

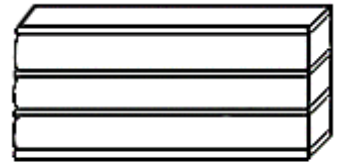

Style: Salsa

Code: CO14
Price: \$3.75 Per in

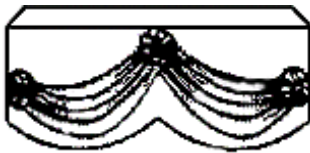

Style: Victoria with Swag & Rosette

Code:
CO1 - Cornice - \$3.00 Per in
S1 - Swag - \$49.50 Each
RO1 - Rosette - \$17.50 Each



Style: Shirred Cornice

Code: CO15
Price: \$3.50 Per in

CORNICE AND SOFT CORNICE - Soft Cornice

| |
|---|
|  |
| Style: Soft Straight Cornice |
| Code: SC1 |
| Price: \$1.50 Per in. |

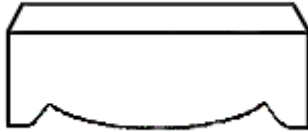
| |
|--|
|  |
| Style: Soft Cornice with Pattern |
| Code: SC2 |
| Price: \$2.00 Per in. |

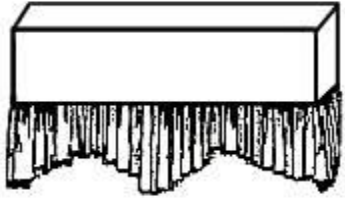
| |
|---|
|  |
| Style: Soft Cornice W/ Gather Bottom |
| Code: SC3 |
| Price: \$2.50 Per in. |

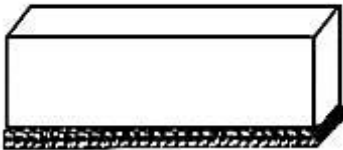
| |
|--|
|  |
| Style: Soft Cornice With Braided |
| Code: SC4 |
| Price \$2.50 Per in. |

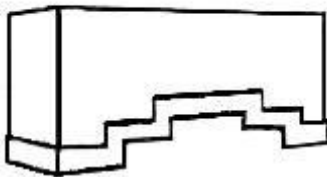
| |
|---|
|  |
| Style: Soft Cornice With Banding |
| Code: SC5 |
| Price: \$2.00 Per in. |

| |
|--|
|  |
| Style: Shirred Soft Cornice |
| Code: SC6 |
| Price: \$3.00 Per in. |

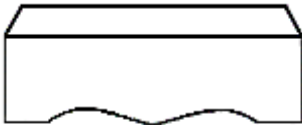
| |
|---|
|  |
| Style: Soft Cornice W/ Pleated or Insert Pleated |
| Code: SC7 |
| Price: \$2.50 per in. |

| | |
|--|--|
|  | <p>Style: Soft Cornice W/ Swag Cascade & Rosettes</p> <p>Code: SC1 : Cornice - \$1.50 /in. S1 : Swag - \$50.00 each RO1 : Rosettes - \$17.50 each</p> |
| <p>Note: All Unusual Soft Cornice, Code: SC8, Price: \$2.50 /in. Accessories are extra</p> | |

CUSHIONS

| Code No. | Description | Price |
|-----------------|---|------------------|
| CU1 | Recover chair's seat Cushion without welt (foam excluded) | \$29.00 each |
| CU2 | Recover chair's seat Cushion with welt (foam excluded) | \$34.00 each |
| CU3 | Recover seat and back cushion for chair (foam excluded) | \$75.00 each |
| CU4 | Chair's cushion with one welt and tie up to 20" square (foam included) | \$48.50 each |
| CU5 | Chair's cushion with top and bottom welt and tie up to 20" square (foam included) | \$53.00 each |
| CU6 | Chair's cushion with skirt around bottom (foam included) | \$82.50 each |
| CU7 | 2" Cushion up to 20" wide | \$2.50 /in. |
| CU8 | 3" Cushion up to 20" wide | \$3.00 /in. |
| CU9 | 4" Cushion up to 20" wide | \$3.00 /in. |
| CU10 | Cushion over 20" wide | \$1.00 extra/in. |

\$15.00 per Zipper

Addition to cushion(s) or pillow (s)

DRAPES (PLEATED & GATHER)

DRAPES (PLEATED & GATHER) - Pleated Drape

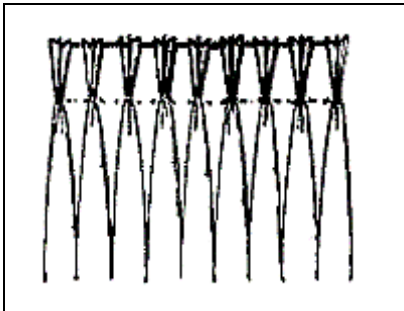

Style: Lined Pinch Pleated

Code: PD1

Price: \$30.00 per width

Unlined

Code: PD2 - Price: \$28.50 /width

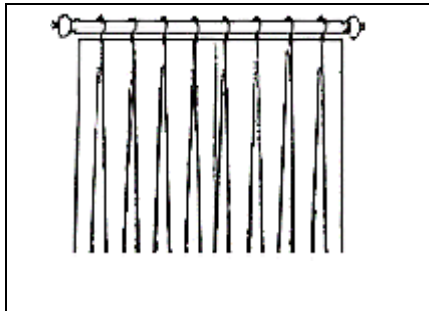

Style: Lined Single Pleated

Code: PD3

Price: \$30.00 Per Width

Unlined

Code: PD4 - Price: \$28.50 /width

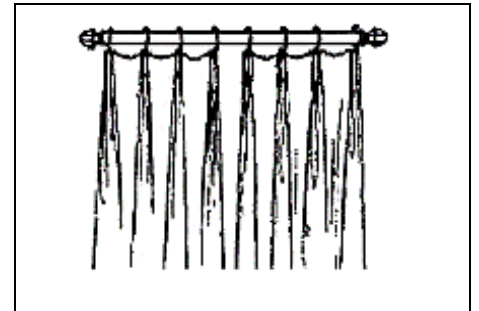

Style: Lined Inverted Pleated

Code: PD5

Price: \$38.50 Per width

Unlined

Code: PD6 - Price: \$37.00 /width

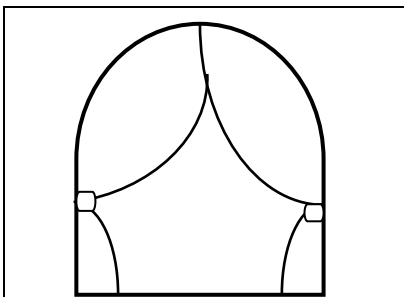

Style: Lined Arch Drape

Code: PD7- \$40.50 per width

Unlined

Code: PD8 - \$38.50 per width

Frame is not included

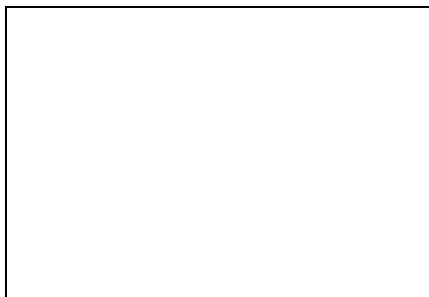

Style: Sheer on Arch

Code: PD9

Price: \$38.50 Per yard

Frame is not included

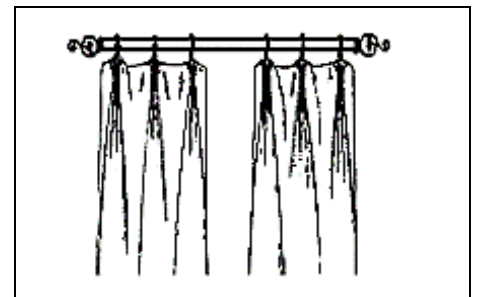

Style: Lined Butterfly

Code: PD10

Price: \$37.00 Per width

Unlined

Code: PD11 - Price: \$38.50 /width

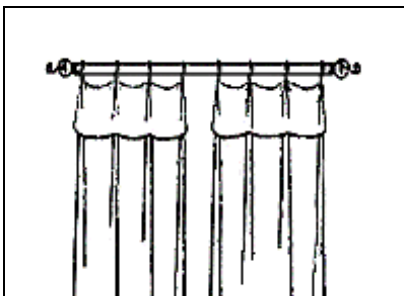

Style: Lined Josephine

Code: PD12

Price: \$48.50 Per width

Unlined

Code: PD13 - Price: \$47.50 /width

Code: PD14-Drape longer than 108"-136"
Price: \$16.00 / per width extra

Code: PD14a-Drape longer than 136"

Price: \$30.50 /per width extra

Code: PD15-Drape gather on board

Price: \$35.00 /width

Code: PD16-Goblet Pleated

Price: \$38.00 /width

Code: PD17-Interlined Labor

Price:\$14.00 /width

**Ripple Fold per width
\$34.50**

Unlined \$32.50

Clear Crinoline per Width \$2.50

DRAPES (PLEATED & GATHER) - Tap Top Drape

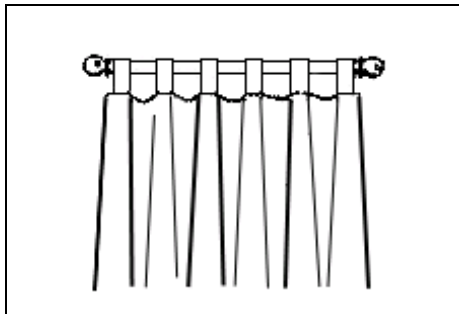

Style: Lined Traditional Tap Top
 Code: TTD1
 Price: \$40.50 per width
 Unlined
 Code: TTD2 - Price: \$38.50 /w

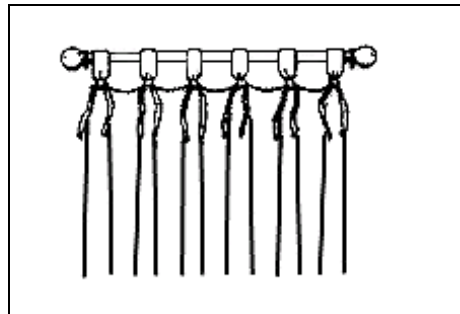

Style: Lined Tap Top with String Knotted Ties
 Code: TTD3
 Price: \$57.00 Per width
 Unlined
 Code: TTD4 - Price: \$43.50 /w

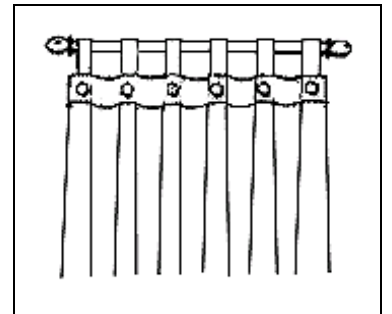

Style: Lined Traditional Tap Top With Banding & Buttons
 code: TTD5
 Price: \$57.00 per width
 Unlined
 Code: TTD6 - Price: \$43.50 /w

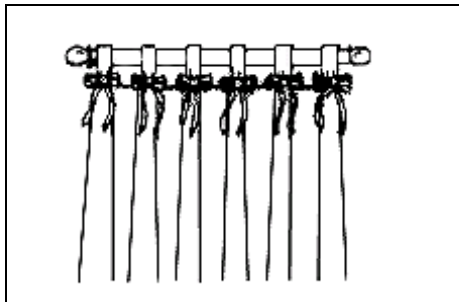

Style: Lined Tap Top With String Bow Ties
 Code: TTD7
 Price: \$57.00 Per width
 Unlined
 Code: TTD8 - Price: \$43.50 /w

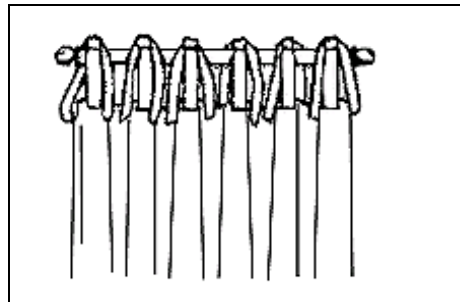

Style: Lined Button Hole Top with 2" Tie Tab
 Code: TTD9
 Price: \$57.00 Per width
 Unlined
 Code: TTD10 - Price: \$43.50 /w

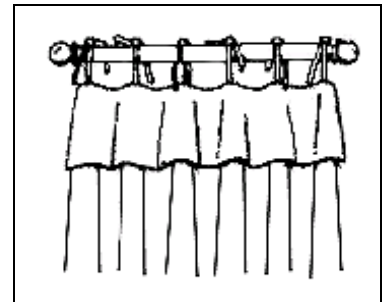

Style: Lined Attached Valance w/ String Tie
 Code: TTD 11
 Price: \$57.00 per width
 Unlined
 Code: TTD12 - Price: \$43.50 /w

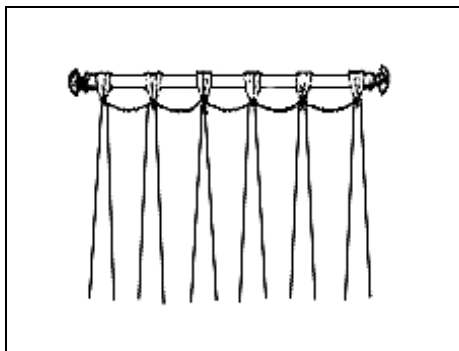

Style: Lined Empire
 Code: TTD 13
 Price: \$55.00 Per width
 Unlined
 Code: TTD 14 - Price: \$41.50 per Width

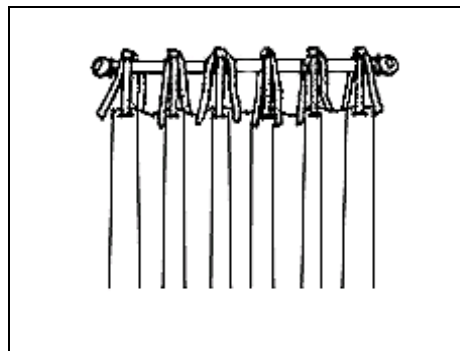

Style: Lined Button Hole Top With 1" Tie Tab
 Code: TTD 15
 Price: \$57.00 Per width
 Unlined
 Code: TTD16 - Price: \$43.50 per Width

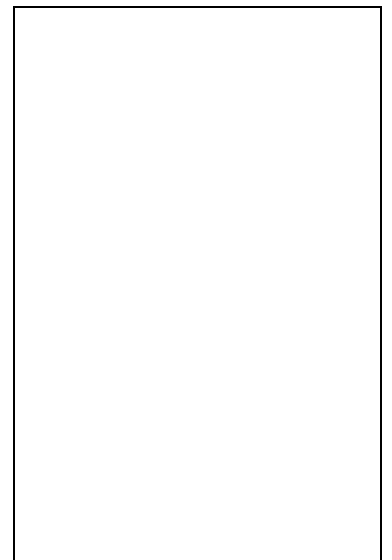

DRAPES (PLEATED & GATHER) - Gather Drape

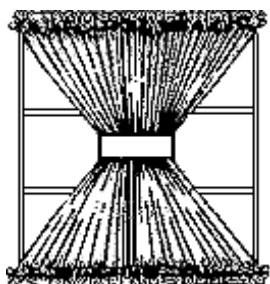

Style: Lined Hour Glass
w/Straight Tie Back

Code: HG1

Price: \$38.50 Per Width

Unlined

Code: HG2

Price: \$35.00 Per Width

Sheer

Code: HG3

Price: \$33.00 Per Yard

Tie Back other than Straight
pay extra \$14.50- Code: HG10

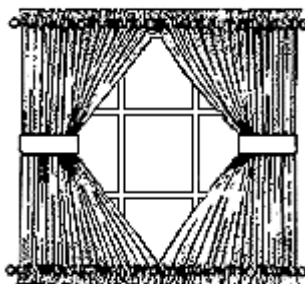

Style: Reversed Hour Glass
w/Straight Tie Back

Same price as Hour Glass

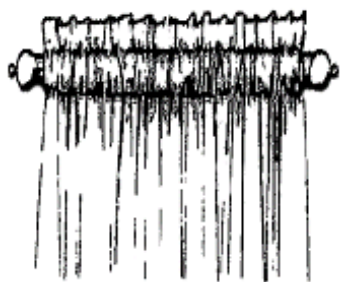

Style: Lined Rod Pocket

Code: GD1

Price: \$26.50 Per Width

Style: Unlined Rod Pocket

Code: GD2 Price: \$24.50 /w

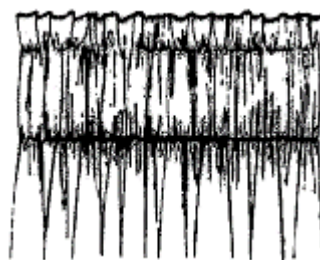

Style: Lined Double R. Rocket

Code: GD3

Price: \$30.00 Per Width

Style: Unlined Double R. Pocket

Code:GD4 - Price: \$28.50 /w

DRAPES (PLEATED & GATHER) - Drape Sheer

| GATHER DRAPE | | |
|---------------------|---------------------------|--------------------|
| Code | Description | Price/Width |
| GD1 | Lined Rod Pocket | \$26.50 |
| GD2 | Unlined Rod Pocket | \$25.00 |
| GD3 | Lined Double Rod Pocket | \$31.00 |
| GD4 | Unlined Double Rod Pocket | \$29.50 |

| HOUR GLASS | | |
|-------------------|--------------------|--------------------|
| Code | Description | Price/Width |
| HG1 | Lined Hour Glass | \$38.50 |
| HG2 | Unlined Hour Glass | \$35.00 |

| SHEERS | | |
|-----------------------|---|-------------------|
| Arch Top Sheer | | |
| Code | Description | Price/Yard |
| ATS | Gather on arch top (frame not included) | \$40.50 |

| HOUR GLASSED | | |
|---------------------|--------------------|-------------------|
| Code | Description | Price/Yard |
| HGS | Sheer Hour Glasged | \$34.50 |

| GATHER SHEER | | |
|---------------------|------------------------------------|-------------------|
| Code | Description | Price |
| GAS1 | 118" Lined RT or RTB Sheer | \$22.50 per yard |
| GAS2 | 118" Unlined RT or RTB Sheer | \$21.00 per yard |
| GAS3 | 48" or 54" Lined RT or RTB Sheer | \$27.00 per width |
| GAS4 | 48" or 54" Unlined RT or RTB Sheer | \$25.50 per width |

| PLEATED SHEER | | |
|----------------------|----------------------------------|-------------------|
| Code | Description | Price |
| PLS1 | 118" Lind Pleated Sheer | \$26.50 per yard |
| PLS2 | 118" Unlined Pleated Sheer | \$25.00 per yard |
| PLS3 | 48" or 54" Lined Pleated Sheer | \$28.00 per width |
| PLS4 | 48" or 54" Unlined Pleated Sheer | \$26.50 per width |

DRAPES (PLEATED & GATHER) - Drape Special Accessories

| ACCESSORIES OR SPECIAL MAKE | | |
|------------------------------------|--|-----------------|
| Code No. | Description | Price |
| SP4 | Making ruffle | \$0.60 per in. |
| SP5 | Making Double ruffle | \$9.00 per yard |
| SP7 | Sew on Banding | \$8.50 per yard |
| SP8 | Sew on Trims | \$5.50 per yard |
| SP9 | Sew on Rings | \$3.00 each |
| RN | Attach Running Welt Cords or Decorative Cords & Gimp | \$3.00 per yard |
| GL | Big Grommet Labor | \$3.50 each |
| WH | Weight Hem – Material + Labor | \$7.00/width |

| REMAKE OR REHEM | | |
|------------------------|----------------------------------|---------------|
| Code No. | Description | Price |
| SP1 | Re hem Lined RT Drape | \$14.00/width |
| SP2 | Re hem Unlined RT Drape | \$13.00/width |
| SP3 | Remake customer's existing drape | \$35.00/width |
| SP4 | Add fabric to existing drapes | \$18.00/width |

DUST RUFFLE

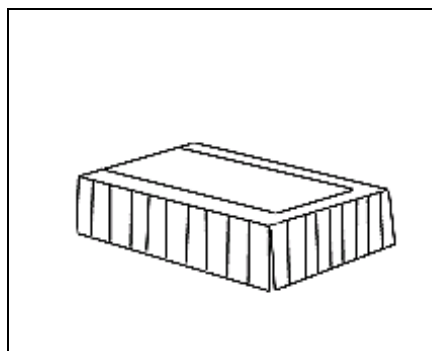

Style: Box Pleated

Twin - Code: DU1 - Price: \$103.50

Full - Code: DU1a - Price: \$115.00

Queen: Code: DU1b - Price: \$126.50

King - Code: DU1c - Price: \$138.00

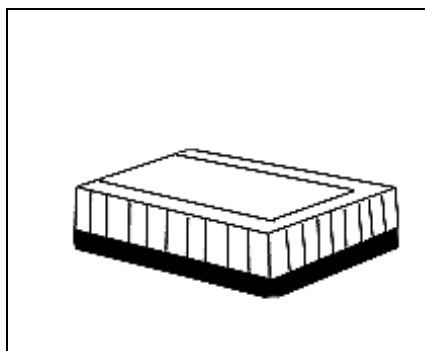

Style: Banded Box Pleated

Twin - Code: DU2 - Price: \$121.00

Full - Code: DU2a - Price: \$132.50

Queen: - Code: DU2b- Price:
\$144.00

King - Code: DU2c - Price: \$155.50

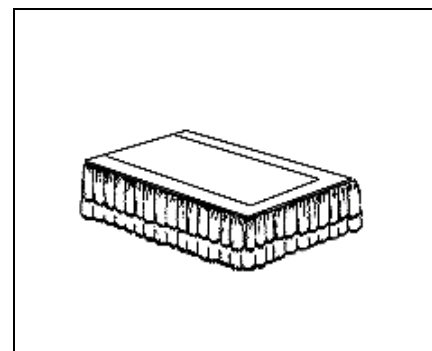

Style: Shirred with Double Ruffle

Twin - Code: DU3 - Price: \$121.00

Full - Code: DU3a - Price: \$132.50

Queen:- Code: DU3b - Price:
\$144.00

King - Code: DU3c - Price: \$155.50

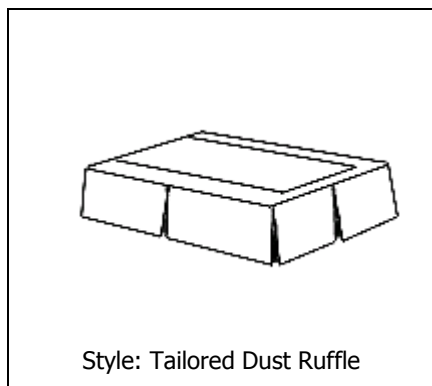

Style: Tailored Dust Ruffle

Twin - Code: DU4 - Price: \$92.00

Full - Code: DU4a - Price: \$101.00

Queen:- Code: DU4b - Price: \$109.50

King - Code: DU4c - Price: \$115.00

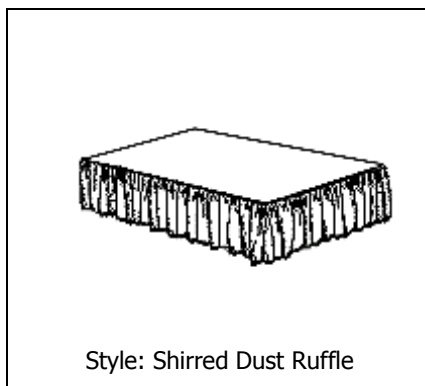

Style: Shirred Dust Ruffle

Twin - Code: DU5 - Price: \$92.00

Full - Code: DU5a - Price: \$101.00

Queen:- Code: DU5b - Price:
\$109.50

King - Code: DU5c - Price: \$115.00

| |
|---|
| Split & Gusset -Price: \$13.00 each corner |
| Lined labor only \$30.50 |
| Interlined labor \$24.50 |

LININGS are not included

DUVETS

| Code | Description | Price |
|-------------|---|------------------------|
| DUV1 | Twin or Full size Duvet with 1/4" welt | \$107.50 each |
| DUV2 | Queen or King size Duvet with 1/4" welt | \$140.00 each |
| DUE3 | Decro (Filling) /1 Layer Extra Padding | \$87.50 each |
| | Split & Gusset | \$12.50 each/corner |
| | Pillow Tuck | \$42.50 extra |

HEAD BOARD

| Code | Description | Price |
|-------------|--------------------|--------------|
| HB1 | Twin or Full | \$345.00 |
| HB2 | Queen or King | \$402.50 |

LINING

| Code No. | Description | Price |
|-----------------|---|------------------|
| 54SIBOL | 54" Silky Black Out White or Ivory | \$8.50 per yard |
| 54LI | 54" white or ivory regular lining | \$5.50 per yard |
| 54BOL | 54" Blackout lining | \$8.00 per yard |
| 54TLI | 54" white or ivory Thermal suede lining | \$6.00 per yard |
| 54ILI | 54" Inter-lining fabric | \$8.00 per yard |
| 54SLI | 54" Sateen Plus Lining | \$8.00 per yard |
| 54SBLI | 54" Solar Block Lining | \$10.00 per yard |

NAPKINS

| Code No. | Description | Price |
|-----------------|--------------------|--------------|
| NA1 | Napkin any size | \$11.00 each |

PLACEMATS

| Code No. | Description | Price |
|-----------------|----------------------------|--------------|
| PL1 | Placemat without (NO) welt | \$25.50 each |
| PL2 | Placemat with welt | \$29.00 each |

ORDERS WITH STOCK MATERIALS

Buttons

| Code No. | Description | Price |
|----------|----------------------------------|-------------|
| 9/16BU | 9/16" Button (labor + material) | \$3.00 each |
| 3/4BU | 3/4" Button (labor + material) | \$3.00 each |
| 7/8BU | 7/8" Button (labor + material) | \$3.00 each |
| 1 1/8BU | 1 1/8" Button (labor + material) | \$3.50 each |
| 1 1/2"BU | 1 1/2" Button (labor + material) | \$5.00 each |
| 2"BU | 2" Button (labor + material) | \$5.50 each |

Cover Welt Cord

| | | |
|--------|---|------------------|
| C1/2WC | Cover 1/2" Welt Cord (labor + material) | \$9.50 per yard |
| C3/4WC | Cover 3/4" Welt Cord (labor + material) | \$11.00 per yard |
| C1WC | Cover 1" Welt Cord (labor + material) | \$13.00 per yard |
| C2WC | Cover 2" Welt Cord (labor + material) | \$14.50 per yard |
| RN | Running Welt Cords, Decorative Cords | \$3.00 per yard |

ORDERS WITH STOCK MATERIALS (Continue)**Make Welt Cord with LIP**

| Code | Description | Price |
|-------------|--|------------------|
| 1/4WC | Make 1/4" Welt Cord (labor + material) | \$8.00 per yard |
| 1/2WC | Make 1/2" Welt Cord (labor + material) | \$9.50per yard |
| 3/4WC | Make 3/4" Welt Cord (labor + material) | \$11.50 per yard |
| 1WC | Make 1" Welt Cord (labor + material) | \$13.00 per yard |
| 2WC | Make 2" Welt Cord (labor + material) | \$14.50 per yard |
| SN | Sew on Welt Cords, or Decorative Cords with lips | \$5.50 per yard |

Sew On Gimps

| Code No. | Description | Price |
|-----------------|-------------------------|-----------------|
| GI | Gimp (labor + material) | \$7.00 per yard |

Twisted or Braided Welt Cord

| Code | Description | Price |
|-------------|---|------------------|
| TWC1 | Twisted 1/2" Welt Cord (labor + material) | \$19.50 per yard |
| TWC2 | Twisted 3/4" Welt Cord (labor + material) | \$22.00 per yard |
| BWC1 | Braided 1/2" Welt Cord (labor + material) | \$31.00 per yard |
| BWC2 | Braided 3/4" Welt Cord (labor + material) | \$33.00 per yard |

Velcro

| Code | Description | Price |
|-------------|--------------------|------------------|
| SV | Single Velcro | \$7.00 per yard |
| DV | Double Velcro | \$10.00 per yard |

Anna's Custom Built Unfinished Table

| Code No. | Description | Price |
|-----------------|--------------------|--------------|
| UT1 | Size 20"x27" | \$71.00 each |
| UT2 | Size 27 1/2"x34" | \$78.50 each |
| UT3 | Size 34 1/2"x40" | \$87.00 each |

Stuffing

| Code No. | Description | Price |
|-----------------|--|--------------|
| SM20 | Stuffing for Twin/Full/Queen size Sham | \$24.00 each |
| SM21 | Stuffing for King size Sham | \$33.50 each |

PILLOWS

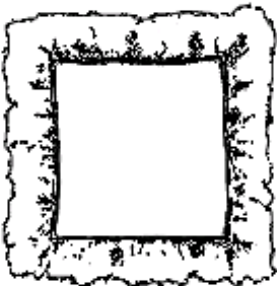

| |
|---------------------------|
| Style: Square with ruffle |
| Code: PI10 |
| Price: \$36.50 each |

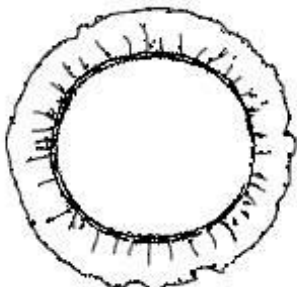

| |
|--------------------------|
| Style: Round with ruffle |
| Code: PI11 |
| Price: \$36.50 each |



| |
|-----------------------|
| Style: Heart w/ruffle |
| Code: PI12 |
| Price: \$36.50 each |



| |
|-------------------------------|
| Style: Square w/double ruffle |
| Code: PI13 |
| Price: \$43.50 each |



| |
|------------------------------|
| Style: Round w/double ruffle |
| Code:PI14 |
| Price: \$43.50 each |



| |
|-------------------------------|
| Style: Square w/Diagonal face |
| Code: PI15 |
| Price: \$36.50 each |

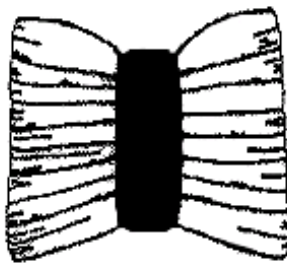

| |
|---------------------|
| Style: Bow Tie |
| Code: PI16 |
| Price: \$36.50 each |

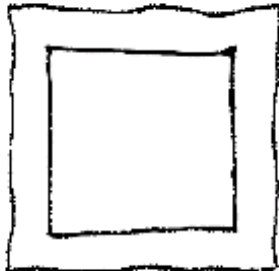

| |
|------------------------|
| Style: Square w/flange |
| Code: PI17 |
| Price: \$36.50 each |

OUR STOCK PILLOW SIZES ARE 16", 18" & 20"
 ALL DIFFERENT SIZES – WE HAVE TO MAKE CUSTOM-
 \$6.00 EXTRA WILL BE ADDED TO EACH PILLOW
 CODE :P17B

PILLOWS SIZE 14"-16" 17" AND LARGER: \$2.25
 EXTRA PER INCH
 CODE : P17A

PILLOWS (Continue)

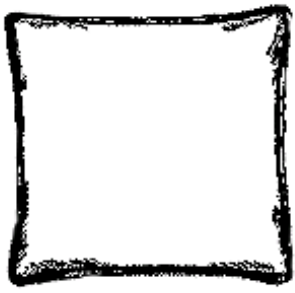

| |
|----------------------------|
| Style: Square with no welt |
| Code: PI1 |
| Price: \$30.00 each |



| |
|---------------------------|
| Style: Round with no welt |
| Code: PI2 |
| Price: \$30.00 each |



| |
|--|
| Style: Square with Tied hourglass-one side |
| Code: PI3 |
| Price: \$43.50 each |



| |
|---------------------|
| Style: Hobo |
| Code: PI4 |
| Price: \$43.50 each |



| |
|--|
| Style: Turkish Corner |
| Code: PI5 |
| Price: \$33.50 each \$37.50 with fringe |

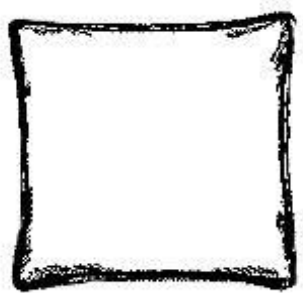

| |
|------------------------------|
| Style: Square with 1/4" welt |
| Code: PI6 |
| Price: \$33.50 each |



| |
|-----------------------------|
| Style: Round with 1/4" welt |
| Code: PI7 |
| Price: \$33.50 each |

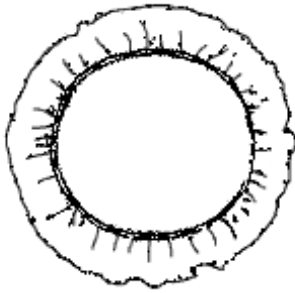

| |
|--------------------------------------|
| Style: Round with 1/4" welt & Ruffle |
| Code: PI8 |
| Price: \$39.50 each |

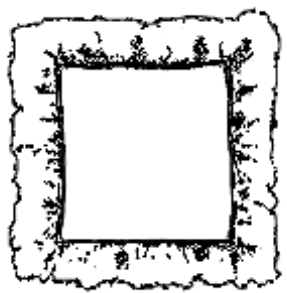

| |
|---------------------------------------|
| Style: Square with 1/4" welt & Ruffle |
| Code: PI9 |
| Price \$39.50 each |

PILLOWS (Continue)

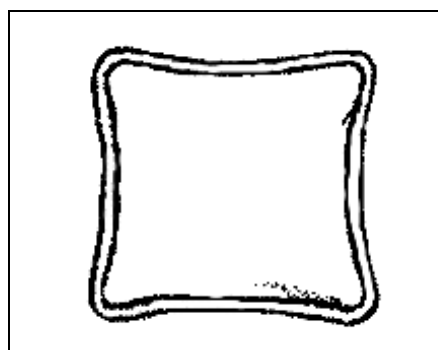

Style: Square with
1/2" welt & 1" Welt

Code: PI18 (1/2") \$36.50 each

Code: PI27 (1") \$37.00 each

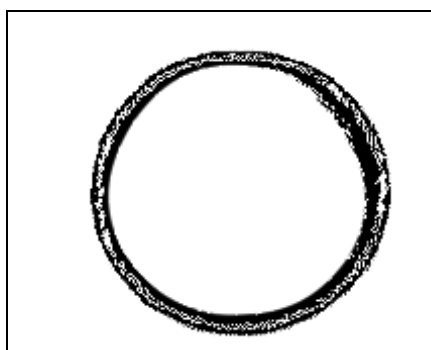

Style: Round with
1/2" welt & 1" Welt

Code: PI19 (1/2") \$36.50 each

Code: PI28 (1") \$37.00 each

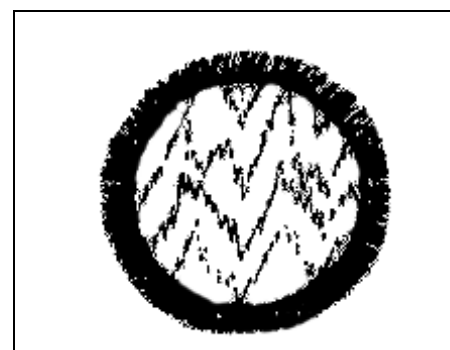

Style: Round with
Trim or Fringe

Code: PI20

Price: \$36.50 each

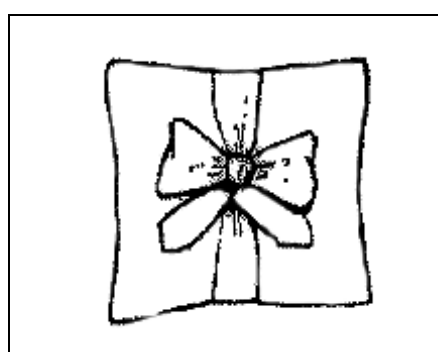

Style: Square with
Bow Tie - one side

Code: PI21

Price: \$43.50 each

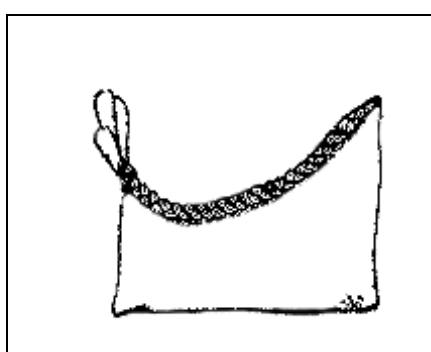

Style: Banana

Code: PI22

Price: \$46.50 each

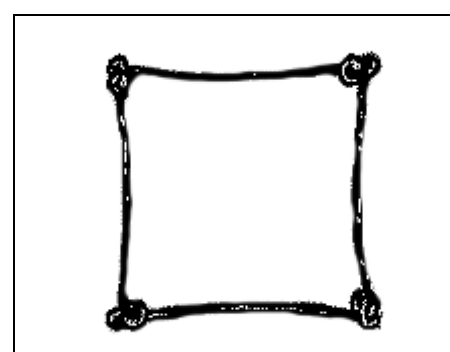

Style: Square with
Knotted Cord

Code: PI23

Price: \$41.00 each

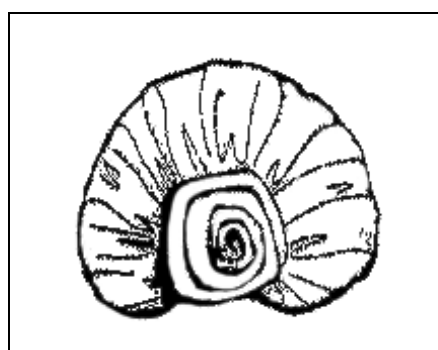

Style: Shirred Shell

Code: PI24

Price: \$46.50 each

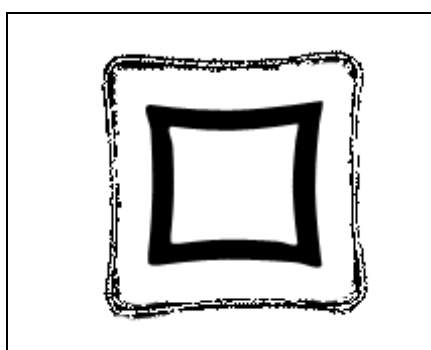

Style: Square w/Banding
and corded edge

Code: PI25

Price: \$43.50 each

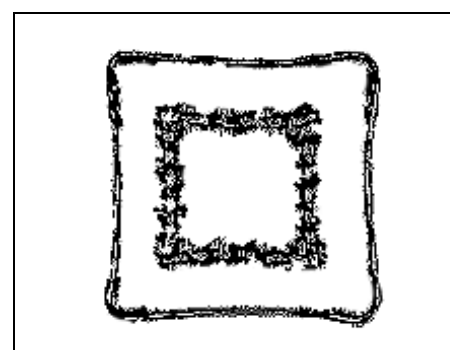

Style: Square with
Trim or Fringe

Code: PI26

Price: \$42.00 each

SPECIAL PILLOWS

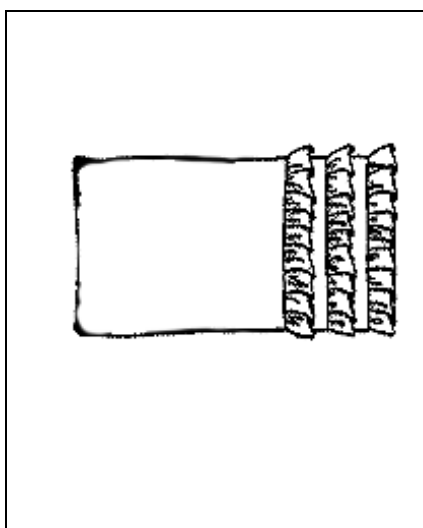
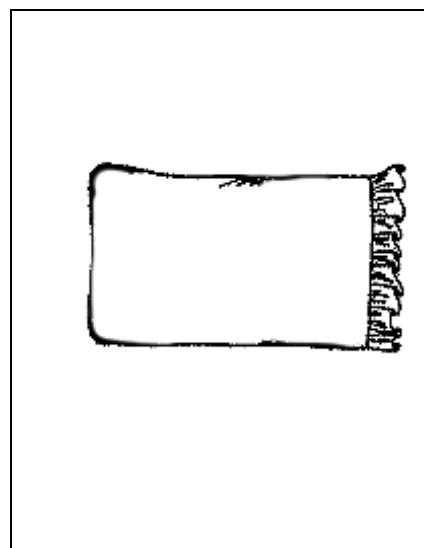
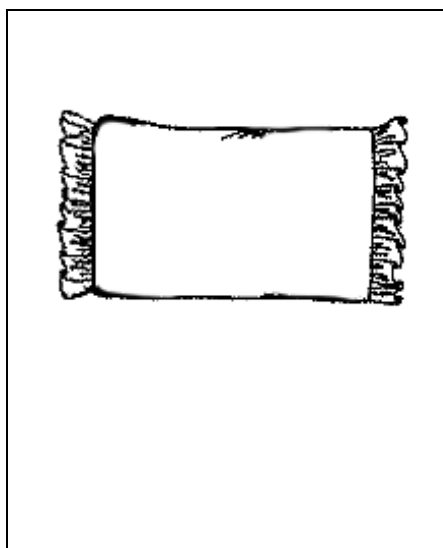
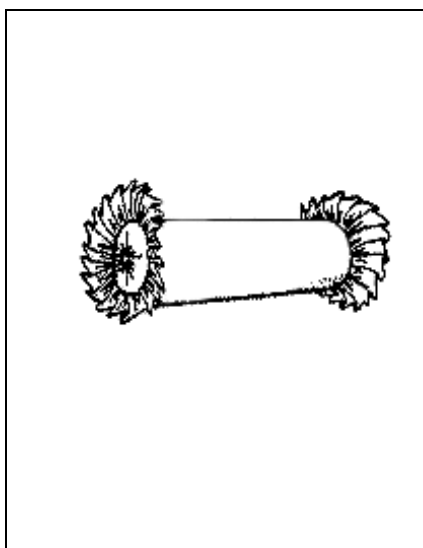
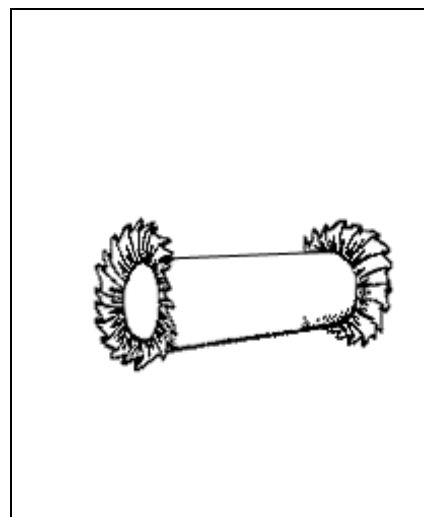
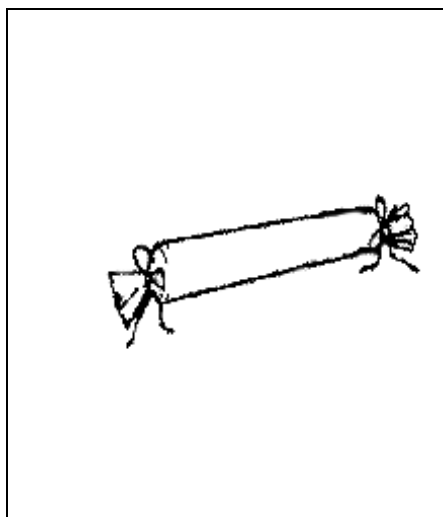
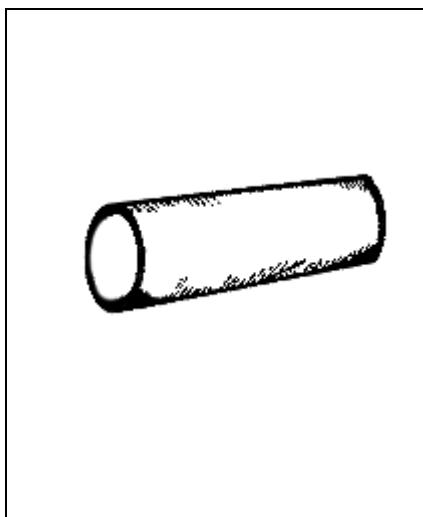

All to be same price
Code: SPI1
Price: \$46.50 Each

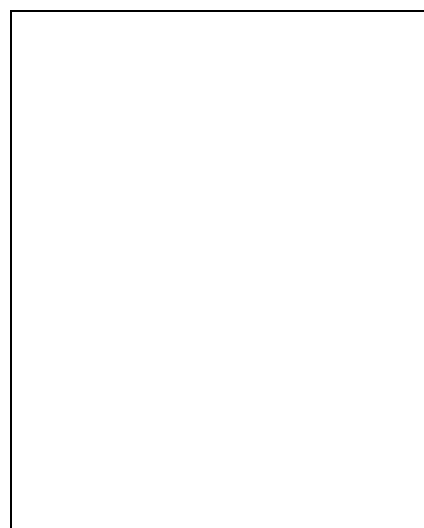

Note: Pillow stuffing is not included. \$6.00 for standard pillows up to 16" x 16". Larger = \$12.00 up to 21" x 21"

SHAMS

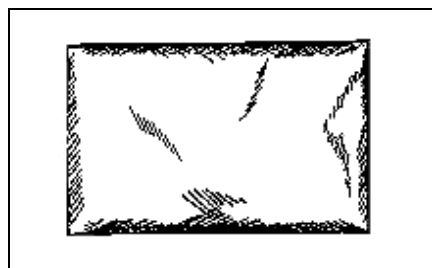

Style: Shirred

Twin - Code: Sh1 - Price: \$30.00

Full - Code: Sh1a - Price: \$44.50

Queen - Code: Sh1b - Price: \$49.50

King - Code: Sh1c - Price: \$52.00

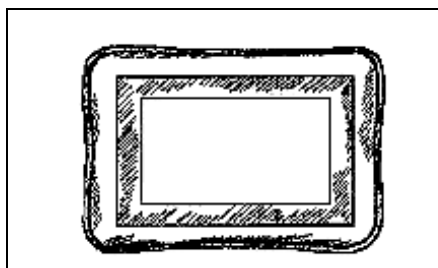

Style: Banded Face
W/Corded Edge

Twin - Code: Sh2 - Price: \$60.50

Full - Code: Sh2a - Price: \$64.50

Queen - Code: Sh2b - Price: \$64.50

King - Code: Sh2c - Price: \$74.00

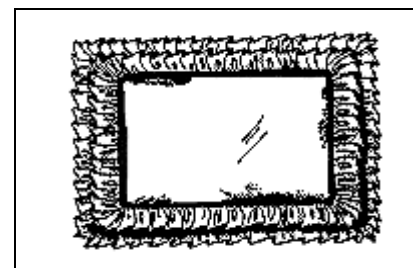

Style: Double Self Lined
Ruffle with Cord

Twin - Code: Sh3- Price: \$69.00

full - Code: Sh3a - Price: \$69.00

Queen - Code: Sh3b - Price: \$72.00

King - Code: Sh3c - Price: \$56.50

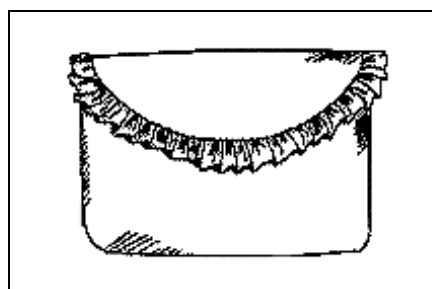

Style: Envelope w/ 1/4" Cord
and Ruffle or 1" Cord

Twin - Code: Sh9- Price: \$60.50

Full - Code: Sh9a - Price: \$64.50

Queen - Code: Sh9b - Price: \$67.50

King - Code: Sh9c - Price: \$74.00

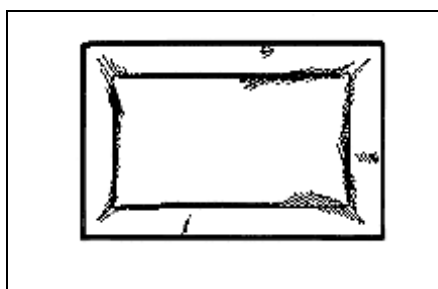

Style: Flange

Twin - Code: Sh4- Price: \$41.50

Full - Code: Sh4a - Price: \$46.00

Queen - Code: Sh4b - Price: \$65.50

King - Code: Sh4c - Price: \$72.50

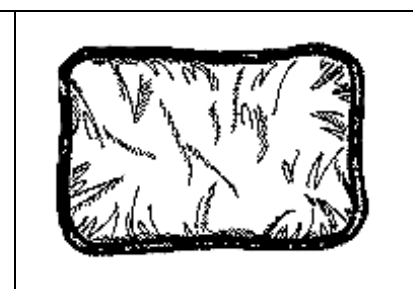

Style: Baggy W/ 1" Cord

Twin - Code: Sh5- Price: \$41.50

Full - Code: Sh5a - Price: \$46.00

Queen - Code: Sh5b - Price: \$65.50

King - Code: Sh5c - Price: \$77.00

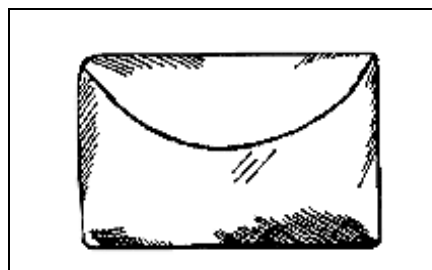

Style: Plain Envelope

Twin - Code: Sh6 - Price: \$49.50

Full - Code: Sh6a - Price: \$54.50

Queen - Code: Sh6b - Price: \$59.50

King - Code: Sh6c - Price: \$64.00

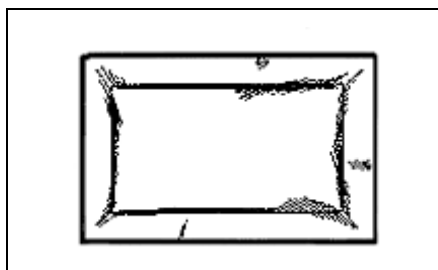

Style: Flage W/ 1/4" Cord
only o outside edge

Twin - Code: Sh7 - Price: \$61.50

Full - Code: Sh7a - Price: \$64.00

Queen - Code: Sh7b - Price: \$73.00

King - Code: Sh7c - Price: \$84.00

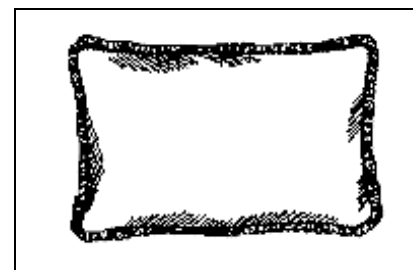

Style: Shirred
With 1" Corded Edge

Twin - Code: Sh8 - Price: \$57.50

Full - Code: Sh8a - Price: \$60.50

Queen - Code: Sh8b - Price: \$65.50

King - Code: Sh8c - Price: \$72.50

SHADE

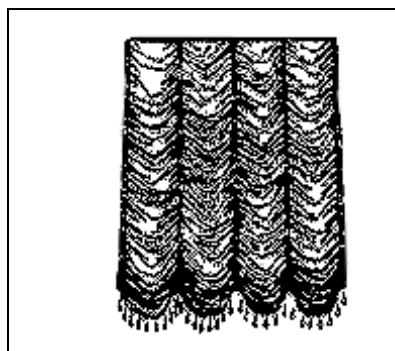

| |
|----------------------------|
| Style: Australian |
| Code AS1 |
| Price: \$16.50 per sq. ft. |

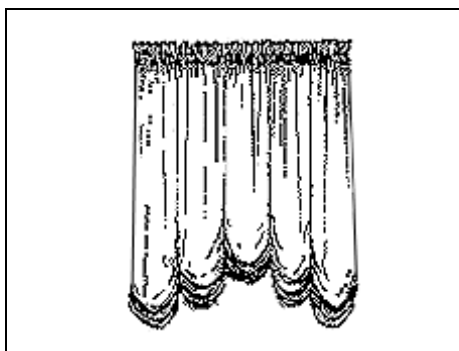

| |
|----------------------------|
| Style: Opera balloon |
| Code: BS1 |
| Price: \$14.00 per sq. ft. |

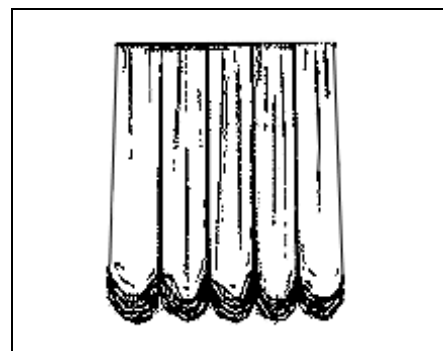

| |
|----------------------------|
| Style: Box Pleated Balloon |
| Code: BS2 |
| Price: \$15.00 per sq. ft. |

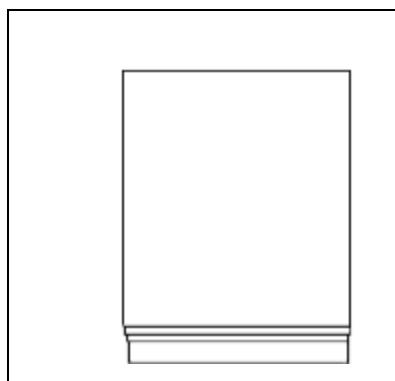

| |
|----------------------------|
| Style: Flat Roman |
| Code: RS1 |
| Price: \$15.50 per sq. ft. |

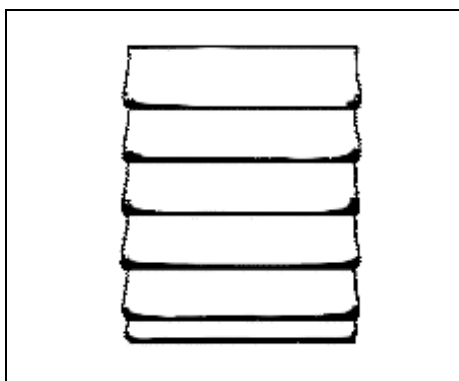

| |
|----------------------------|
| Style: Folded Roman |
| Code: RS2 |
| Price: \$20.50 per sq. ft. |

Operable Up & down

Flat Relax with curve at Bottom
 up to 35" - \$29.00
 36" & up - \$52.00

SUNBURST

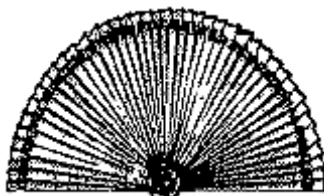

| 1/2 ROUND OR EYEBROW SUNBURST | | |
|--------------------------------------|---|---------------|
| Code No. | Description | Price |
| SU1 | Sunburst up to 37" - 4 yards 118" sheer | \$126.00 each |
| SU2 | Sunburst 38"- 48" - 5 yards 118" sheer | \$141.50 each |
| SU3 | Sunburst 49" - 60" - 6 1/2 yards 118" sheer | \$204.50 each |
| SU4 | Sunburst 61" to 72" - 8 yards 118" sheer | \$251.50 each |
| SU5 | Sunburst 73" to 96" - 10 yards 118" sheer | \$313.50 each |

| FULL ROUND SUNBURST | | |
|----------------------------|---------------------|---------------|
| Code No. | Description | Price |
| SU6 | Sunburst up to 37" | \$251.50 each |
| SU7 | Sunburst 38"- 48" | \$282.50 each |
| SU8 | Sunburst 49" - 60" | \$400.50 each |
| SU9 | Sunburst 61" to 72" | \$494.00 each |
| SU10 | Sunburst 73" to 96" | \$627.00 each |

| 1/2 ROUND OR EYEBROW SUNBURST with RETURN | | |
|--|---------------------|---------------|
| Code No. | Description | Price |
| SU11 | Sunburst up to 37" | \$164.50 each |
| SU12 | Sunburst 38"- 48" | \$188.50 each |
| SU13 | Sunburst 49" - 60" | \$243.50 each |
| SU14 | Sunburst 61" to 72" | \$290.50 each |
| SU15 | Sunburst 73" to 96" | \$361.00 each |

| FULL ROUND SUNBURST with RETURN | | |
|--|---------------------|---------------|
| Code No. | Description | Price |
| SU16 | Sunburst up to 37" | \$212.00 each |
| SU17 | Sunburst 38"- 48" | \$227.50 each |
| SU18 | Sunburst 49" - 60" | \$282.50 each |
| SU19 | Sunburst 61" to 72" | \$329.50 each |
| SU20 | Sunburst 73" to 96" | \$400.50 each |

SWAGS & CASCADES

PLEASE NOTE:

1. All accessories to be charged separately
2. Swag & Cascade are priced together; However, if cascades are longer than 42", an additional \$14.75/pair
Code: Ca2

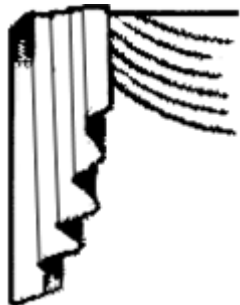
| |
|---|
|  |
| Style: Cascade |
| Code : CA1 |
| Price: \$52.00 per pair |

| |
|--|
| SCARF SWAGS |
| SC101, Scarf Railroad fabric-Unlined, Price = \$14.50 /Yard |
| SC102, Scarf-Railroad fabric lined W/banding, Price = \$15.50 /Yard |
| SC103, Scarf-Railroad fabric fold & tack down lined - Price = \$31.50 /Yard |
| SC104, Scarf-Railroad fabric fold& tack down unlined -Price = \$26.50 /Yard |
| Single Swag Code: S1 - Price: \$49.50 each |

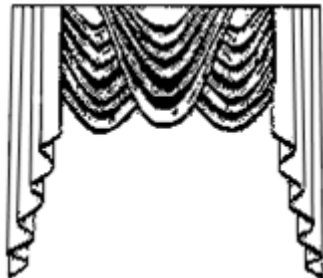
| |
|---|
|  |
| Style: Swag & Cascade |
| Code: SW1 |
| Price: \$3.00 per in. |

| |
|--|
|  |
| Style: Pole Swag |
| Rod Code: SW2 \$3.50 per in. |
| Covered Pole Code: SW2a - Price: \$4.00 per in. |

| |
|--|
|  |
| Style: Westlake |
| Code: SW3 |
| Price: \$3.00 per in. |

| |
|--|
|  |
| Style: Harley |
| Code: SW4 |
| Price: \$3.00 per in. |

| |
|---|
|  |
| Banded Astor |
| code: SW5 |
| Price: \$3.00 per in. |

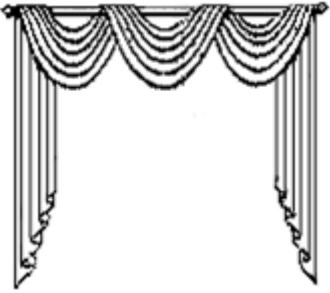
| |
|--|
|  |
| Style: Pole Swag W/long Cascade |
| Price based on Pole & long Cascade |

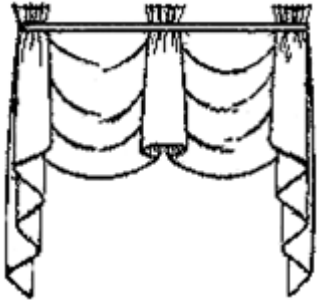
| |
|---|
|  |
| Style: Elizabeth |
| Code: SW6 |
| Price: \$3.50 per in. |

SWAGS & CASCADES (Continue)

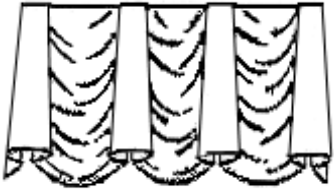

| |
|----------------------|
| Style: Kingston |
| Code: KI1 |
| Price: \$3.50 per in |

Code: KI2, Style: Kingston with cascade
Price: \$4.50 per in.

Code: KI3, Style: Arch Kingston
Price: \$5.50 per in.

Code: SW14, Style: Interline Cascade
Price: \$1.50 extra

Code: SW15, Free Hang Swag
Price: \$3.50 per in.

Code: SW16, Unusual Swag
Price: \$4.50 per in.

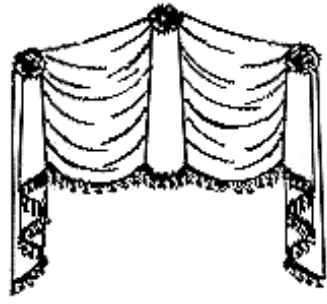

| |
|-----------------------|
| Style: Washingtonian |
| Code: SW7 |
| Price: \$5.50 per in. |

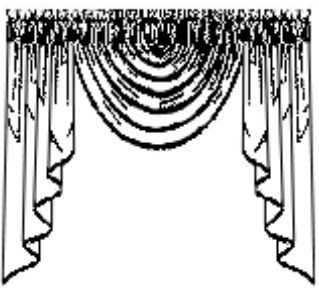

| |
|------------------------|
| Style: Rod Pocket Swag |
| Code: SW8 |
| Price: \$3.00 per in. |



| |
|-----------------------|
| Style: Moritz |
| Code: SW9 |
| Price: \$4.50 per in. |

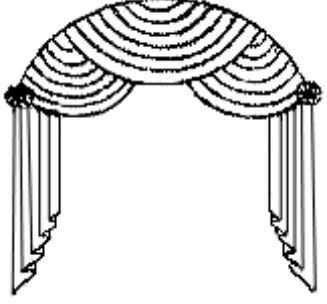

| |
|--|
| Style: Arch Swag |
| Code: SW10 |
| Price: \$4.50 per in. Frame not included |

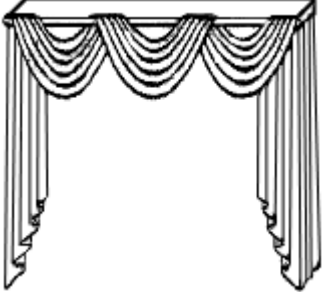

| |
|-----------------------------------|
| Style: Pole Swag mounted on board |
| Code: SW11 |
| Price: \$4.00 per in. |



| |
|------------------------|
| Style: Single Westlake |
| Code: SW12 |
| Price: \$3.00 per in. |

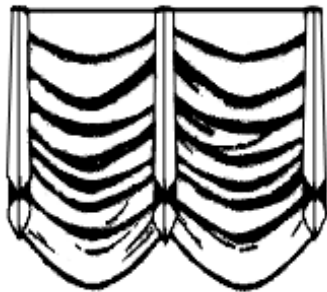

| |
|-----------------------|
| Style: Australian |
| Code: SW13 |
| Price: \$3.00 per in. |

SWAGS & CASCADES (Continue)

| SPECIAL MAKE | | |
|---------------------|---------------------------------|-----------------|
| Code No. | Description | Price |
| SP4 | Making ruffle | \$0.60 per in. |
| SP7 | Sew on Banding | \$8.00 per yard |
| SP8 | Sew on Trims | \$6.00 per yard |
| SP9 | Sew on Rings | \$3.00 each |
| RN | Running Decorative Cords | \$3.00 per yard |
| | | |
| ARCH FRAME | | |
| Code No. | Description | Price |
| AF1 | Arch Frame up to 35" wide | \$75.50 each |
| AF2 | Arch Frame 36"-47" wide | \$82.50 each |
| AF3 | Arch Frame 48"-59" wide | \$105.00 each |
| AF4 | Arch Frame 60"-72" wide | \$127.50 each |
| AF5 | Arch Frame larger than 73" wide | \$202.00 each |

| COVER PVC PIPE OR WOOD POLES | | |
|-------------------------------------|--|----------------|
| Code No. | Description | Price |
| 1PVC | 1 1/2" PVC (minimum charge: 3'-00") Pipe included | \$1.00 per in. |
| 2PVC | 2 1/2" PVC (minimum charge: 3'-00") Pipe included | \$1.00 per in. |
| 3PVC | 3"PVC (minimum charge: 3'-00") Pipe included | \$1.00 per in. |
| WO | Cover Wood Pole any size-gather or flat (labor only) | \$0.50 per in. |
| WF | Cover Wood Finial any size | \$6.50 each |

| COVER WELT CORD | | |
|------------------------|---|------------------|
| Code | Description | Price |
| C1/2WC | Cover 1/2" Welt Cord (labor + material and running) | \$10.00 per yard |
| C3/4WC | Cover 3/4" Welt Cord (labor + material and running) | \$11.00 per yard |
| C1WC | Cover 1" Welt Cord (labor + material and running) | \$13.00 per yard |
| C2WC | Cover 2" Welt Cord (labor + material and running) | \$14.50 per yard |

SWAGS & CASCADES (Continue)

| COVER WELT CORD with LIP | | |
|---------------------------------|---|------------------|
| Code | Description | Price |
| 1/4WC | Make 1/4" Welt Cord (labor + material and sewed on) | \$8.00 per yard |
| 1/2WC | Make 1/2" Welt Cord (labor + material and sewed on) | \$10.00 per yard |
| 3/4WC | Make 3/4" Welt Cord (labor + material and sewed on) | \$11.00 per yard |
| 1WC | Make 1" Welt Cord (labor + material and sewed on) | \$13.00 per yard |
| 2WC | Make 2" Welt Cord (labor + material and sewed on) | \$14.50 per yard |
| SN | Sew on Decorative Cords with lips | \$5.00 per yard |

| COVER FOAM BALLS | | |
|-------------------------|---------------------------------|--------------|
| Code No. | Description | Price |
| 4FB | 4" Foam Ball (labor + material) | \$11.50 each |
| 6FB | 6" Foam Ball (labor + material) | \$12.50 each |

| SHEERS | | |
|---------------|---------------------------|-----------------|
| Code | Description | Price |
| SH1 | 118" White or Ivory Sheer | \$9.50 per yard |
| SH2 | 118" White or Ivory Batis | \$9.50 per yard |
| | | |

| SHOWER CURTAIN | | |
|-----------------------|--------------------|----------------|
| Code | Description | Price |
| SHO | SHOWER CURTAIN | \$39.00 /width |

| TWISTED OR BRAIDED WELT CORD | | |
|-------------------------------------|---|------------------|
| Code | Description | Price |
| TWC1 | Twisted 1/2" Welt Cord (labor + material and running) | \$19.50 per yard |
| TWC2 | Twisted 3/4" Welt Cord (labor + material and running) | \$22.00 per yard |
| BWC1 | Braided 1/2" Welt Cord (labor + material and running) | \$31.00 per yard |
| BWC2 | Braided 3/4" Welt Cord (labor + material and running) | \$33.00 per yard |

| VELCRO | | |
|---------------|--------------------|------------------|
| Code | Description | Price |
| SV | Single Velcro | \$7.00 per yard |
| DV | Double Velcro | \$10.00 per yard |

TABLE SKIRT





| | | |
|---|---|---|
|  |  |  |
| <p>Style: Plain Round Skirt</p> | <p>Style: Plain Round Skirt With Welt Edge</p> | <p>Style: Round Skirt with Australian Shirring</p> |
| <p>Lined Code: TS1 - Price: \$66.50 each</p> | <p>Lined 1/4" Welt - Code: TS3 - Price: \$76.00 ea. 1/2" Welt - Code: TS4 - Price: \$78.50 ea. 3/4" Welt - Code: TS5 - Price: \$82.00 ea. 1" Welt - Code: TS6 - Price: \$85.00 ea.</p> | <p>Lined Code: TS11 - Price: \$133.50 each</p> |
| <p>Unlined Code: TS2 - Price: \$51.00 each</p> | <p>Unlined 1/4" Welt - Code: TS7 - Price: \$66.50 ea. 1/2" Welt - Code: TS8 - Price: \$71.00 ea. 3/4" Welt - Code: TS9 - Price: \$79.00 ea. 1" Welt - Code: TS10 - Price: \$82.00 ea.</p> | <p>Unlined Code: TS12 - Price: \$117.50 each</p> |
|  |  |  |
| <p>Style: Ruffle Skirt & Overlay</p> | <p>Style: Round & Square Overlay</p> | <p>Style: Round Overlay With Bows (three)</p> |
| <p>Lined Skirt Code: TS13 - Price: \$110.00 each</p> | <p>Lined Code: TS17 - Price: \$41.00 each</p> | <p>Lined Code: TS19 - Price: \$126.00 each</p> |
| <p>Unlined Skirt Code: TS14 - Price: \$102.50 each</p> | <p>Unlined Code: TS18 - Price: \$34.50 each</p> | <p>Unlined Code: TS20 - Price \$117.50 each</p> |
| <p>Lined Overlay Code: TS15 - Price: \$78.50 each</p> | | |
| <p>Unlined Overlay Code: TS16 - Price: \$71.00 each</p> | | |

TABLE RUNNER

| SKIRT | | |
|-----------------|--|---------------|
| Code No. | Description | Price |
| TS1 | Lined Plain Round Skirt | \$66.50 each |
| TS2 | Unlined Plain Round Skirt | \$51.00 each |
| TS3 | Lined Plain Round Skirt with 1/4" welt | \$76.00 each |
| TS4 | Lined Plain Round Skirt with 1/2" welt | \$78.50 each |
| TS5 | Lined Plain Round Skirt with 3/4" welt | \$82.00 each |
| TS6 | Lined Plain Round Skirt with 1" welt | \$85.00 each |
| TS7 | Unlined Plain Round Skirt with 1/4" welt | \$66.50 each |
| TS8 | Unlined Plain Round Skirt with 1/2" welt | \$71.00 each |
| TS9 | Unlined Plain Round Skirt with 3/4" welt | \$78.50 each |
| TS10 | Unlined Plain Round Skirt with 1" welt | \$82.00 each |
| TS11 | Lined Round Skirt with Australian Shirring | \$133.50 each |
| TS12 | Unlined Round Skirt with Australian Shirring | \$117.50 each |
| TS13 | Lined Ruffle Skirt | \$110.00 each |
| TS14 | Unlined Ruffle Skirt | \$102.50 each |

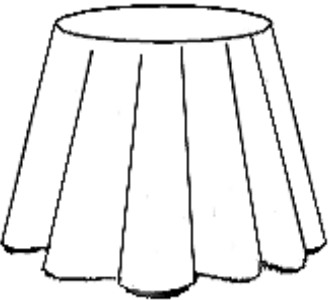
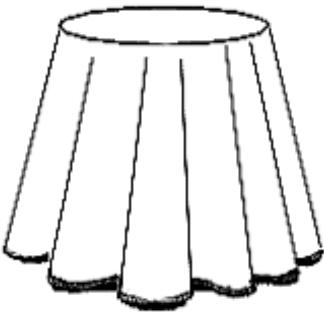
| OVERLAY | | |
|-----------------|---------------------------------------|---------------|
| Code No. | Description | Price |
| TS15 | Lined Ruffle Overlay | \$78.50 each |
| TS16 | Unlined Ruffle Overlay | \$71.00 each |
| TS17 | Lined Round or Square Overlay | \$41.00 each |
| TS18 | Unlined Round or Square Overlay | \$34.50 each |
| TS19 | Lined Round Overlay with three Bows | \$126.00 each |
| TS20 | Unlined Round Overlay with three Bows | \$117.50 each |

| TABLE RUNNER | | |
|---------------------|-----------------------------|--------------|
| Code No. | Description | Price |
| TS21 | Table Runner with no welt | \$39.50 each |
| TS22 | Table Runner with 1/4" welt | \$55.50 each |
| TS23 | Table Runner with banding | \$71.00 each |

TIE-BACKS

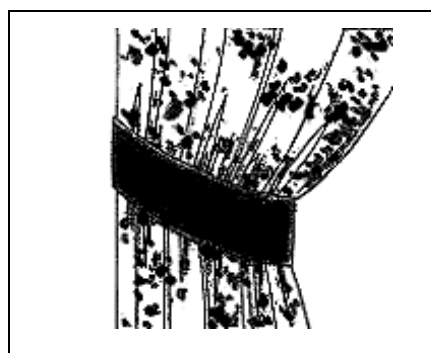

Style: Straight Tie - Back

Code: TB1, Price: \$20.50 per pair

With 1/4" Welt

Code: TB2 - Price: \$26.50 per pair

With 1/2" Welt

Code: TB2a - \$28.50 per pair

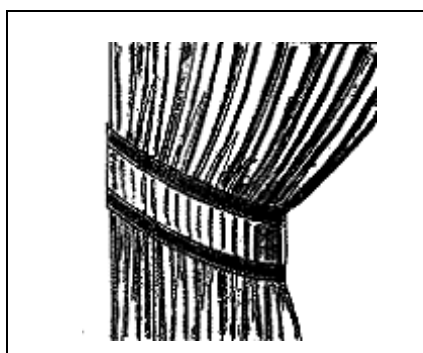

Style: Straight Tie-Back W/Banding

Code: TB3

Price: \$32.00 per pair



Style: Contour Plain

Code: TB4

Price: \$29.50 per pair

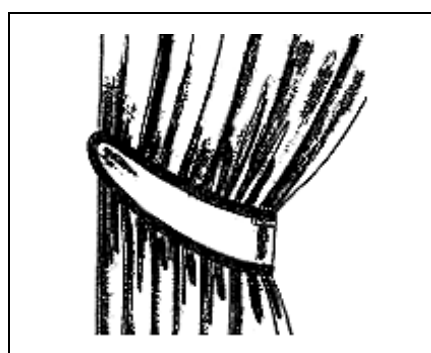

Style: Contour Tie-Back w/Welt

With 1/4" Welt

Code: TB5 - Price: \$31.50 per pair

With 1/2" Welt

Code: TB5a - Price: \$33.00 per pair

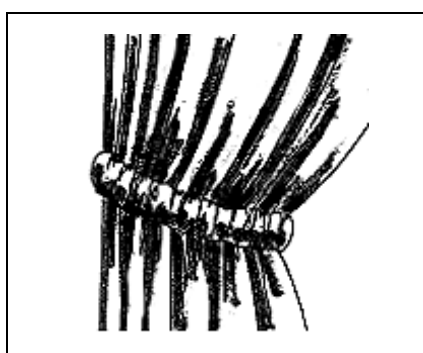

Style: Shirred Jumbo Welt Cord

Code: TB6

Price: \$25.00 per pair

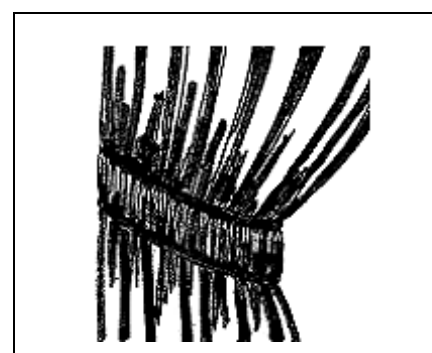

Straight Shirred Tie-Back

Code: TB7

Price: \$31.50 per pair

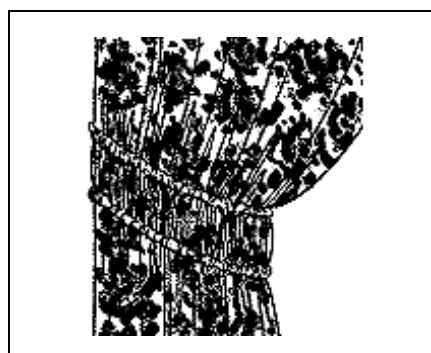

Style: Straight Shirred with 1/4" Welt

Code: TB8

Price: \$33.00 per pair

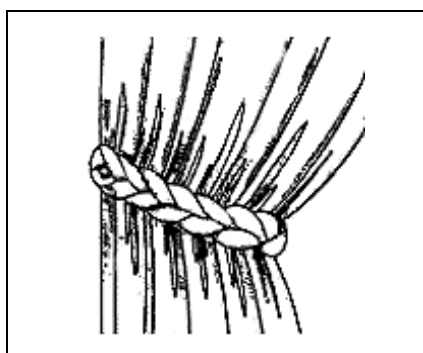

Style: Braided Tie-Back

Code: TB9

Price: \$53.50 per pair



| |
|--|
| |
| |
| |

VALANCE

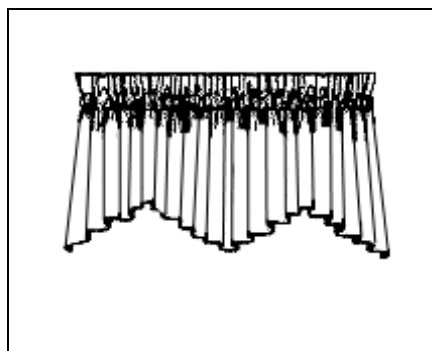

Style: Designed Rod Pocket Valance

Code: VA1

Price: \$28.50 per width

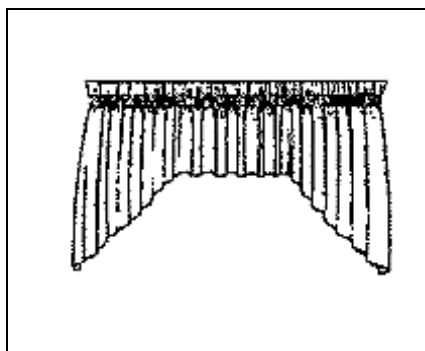

Style: Gather on Board Valance

Code: VA2

Price: \$31.50 per width

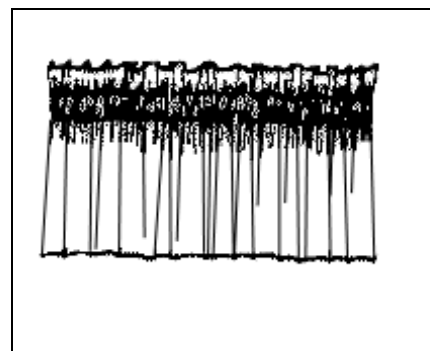

Style: Straight Rod Pocket Valance

Code: VA3

Price: \$25.00 per width

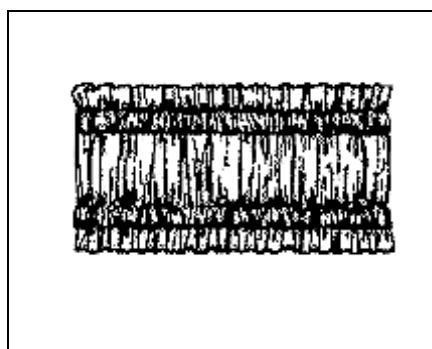

Style: Double Rod Pocket Valance

Code: VA4

Price \$25.00 per width

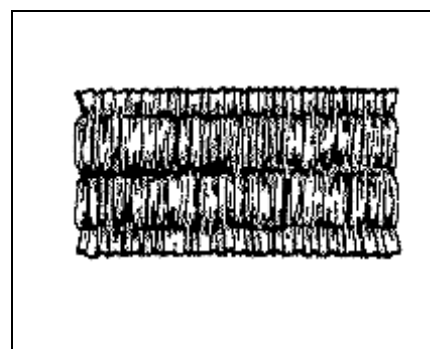
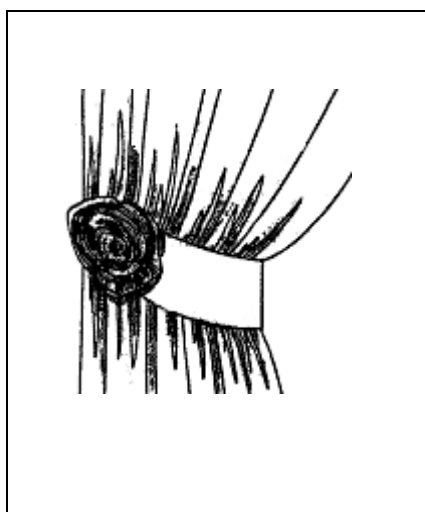

Style: Double Continental Valance

Code: VA5

Price: \$21.50 per width

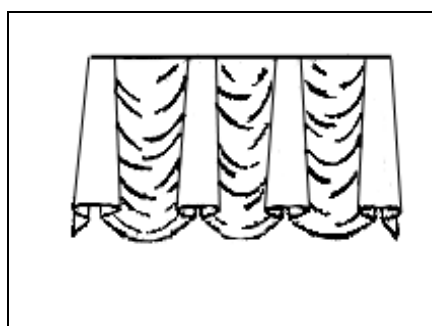

Style: York with Banding Valance

Code: VA6

Price: \$3.50 per in.

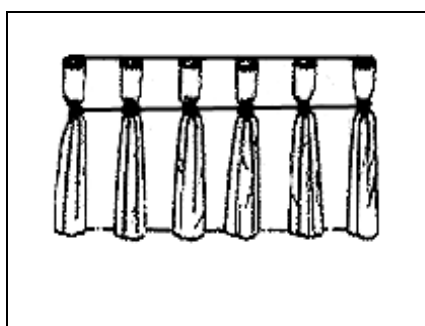

Style: Goblet Pleat Valance

Code: VA7

Price: \$3.00 per in.

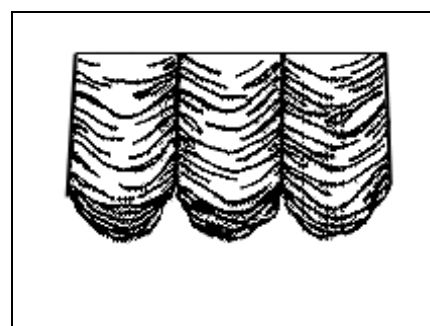

Style: Sheraton Valance

Code: VA8

Price: \$3.00 per in.

VALANCE (Continue)

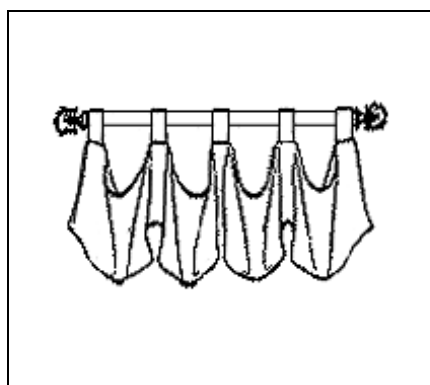

Style: Florentine Valance
 Code: VA9
 Price: \$3.00 per in.

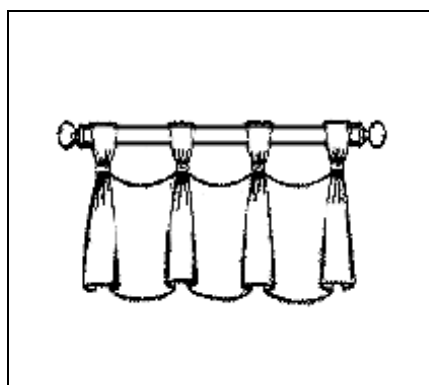

Style: Empire Valance
 Code: VA10
 Price: \$3.00 per in.

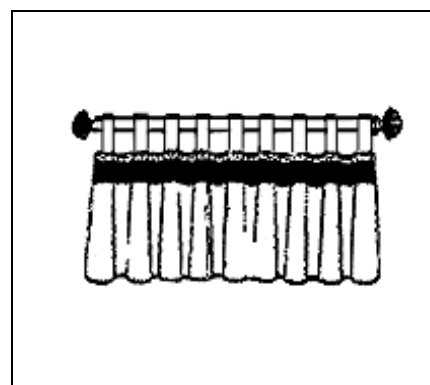

Style: Tab Valance with Banding Va.
 Code: VA11
 Price: \$4.00 per in.

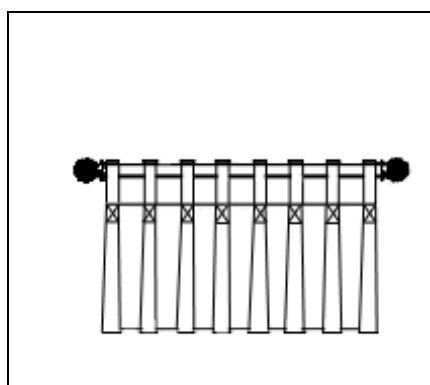

Style: Tab Valance
 Code: VA12
 Price: \$3.00 per in.

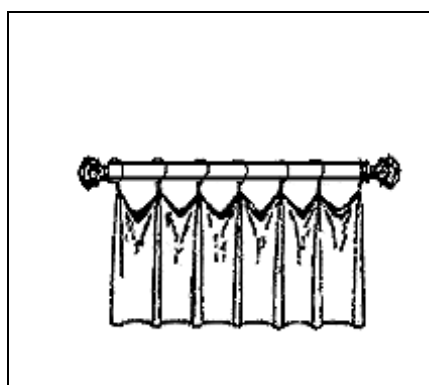

Style: Napoleon Valance
 Code: VA13
 Price: \$3.00 per in.

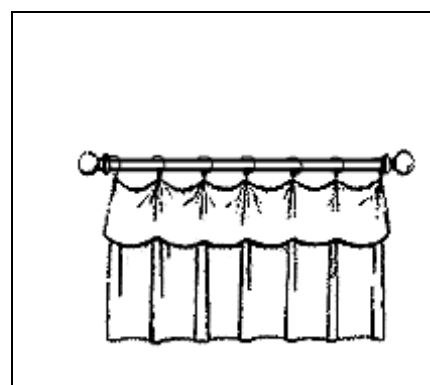

Style: Josephine Valance
 Code: VA14
 Price: \$3.50 per in.

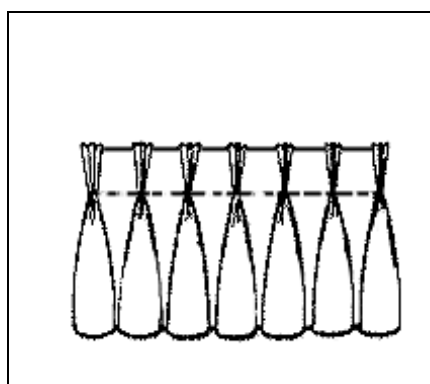

Style: Pleated Valance on Board
 No Banding
 Code: VA15 - Price: \$2.50 per in.
 With Banding
 Code: VA16 - Price: \$3.00 per in.

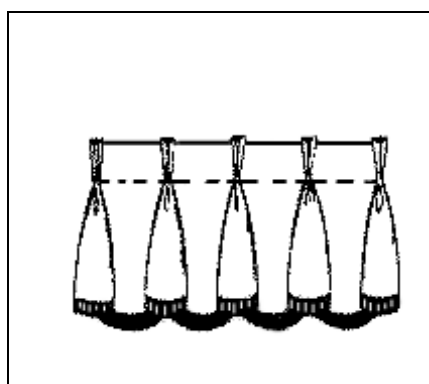

Style: queen Ann Valance
 No Banding
 Code: VA17 - Price: \$3.00 per in.
 With Banding
 Code: VA18 - Price: \$3.50 per in.

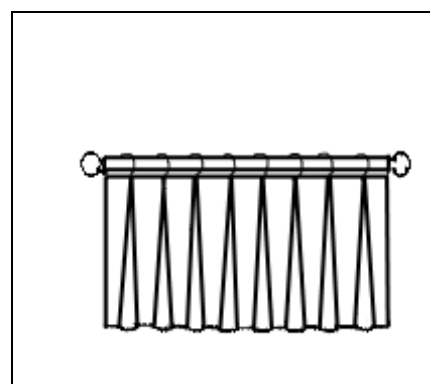

Style: Single Pleated Valance
 Code: VA19
 Price: \$2.50 per in.

VALANCE (Continue)



Style: Gather Balloon Valance

on Board
Code: VA20-Price:\$49.50 per width

On Rod
Code: VA21-Price:\$38.00 per width

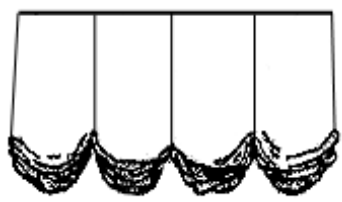

Style: Box Balloon Valance

Code: VA22

Price: \$4.50 per in.

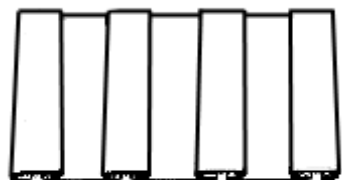

Style: Box Pleated Valance

Code:VA23

Price: \$2.50 per in.



Style: Inverted Pleated Valance

Code: VA24

Price: \$2.50 per in.

VA24A
Inverted Pleated Valance
With insert **\$3.00** per inch
Or Unusual Valance.

PLAT ROMAN VALANCE
CODE = VA31
PRICE = \$3.00/INC.



Style: Handkerchief Valance

No Banding
Code: VA25 - Price: \$2.50 per in.

With Banding
Code: VA25 + SP7

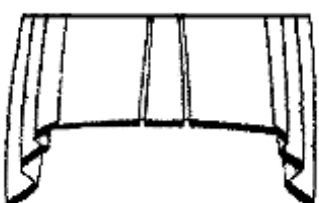

Style: Jefferson Valance

Code: VA27

Price: \$2.50 per in.



Style: Rod Sleeve

Pocket only
Code: VA28-Price: \$8.50 per width

With Header
Code: VA29-Price: \$11.50 per width

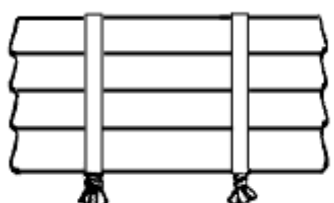

Style: Folded roman Valance

Code: VA30

Price: \$3.50 per in.

VALANCE (Continue)

| ACCESSORIES OR SPECIAL MAKE | | |
|------------------------------------|--------------------|-----------------|
| Code No. | Description | Price |
| SP4 | Making ruffle | \$1.00 per in. |
| SP7 | Sew on Banding | \$8.00 per yard |
| SP8 | Sew on Trims | \$4.50 per yard |
| SP9 | Sew on Rings | \$2.50 each |

| ARCH FRAME | | |
|-------------------|---------------------------------|---------------|
| Code No. | Description | Price |
| AF1 | Arch Frame up to 35" wide | \$75.50 each |
| AF2 | Arch Frame 36"-47" wide | \$82.50 each |
| AF3 | Arch Frame 48"-59" wide | \$105.00 each |
| AF4 | Arch Frame 60"-72" wide | \$127.00 each |
| AF5 | Arch Frame larger than 73" wide | \$202.00 each |

| COVER PVC PIPE OR WOOD POLES | | |
|-------------------------------------|--|----------------|
| Code No. | Description | Price |
| 1PVC | 1 1/2" PVC (minimum charge: 3'-00") Pipe included | \$1.00 per in. |
| 2PVC | 2 1/2" PVC (minimum charge: 3'-00") Pipe included | \$1.00 per in. |
| 3PVC | 3" PVC (minimum charge: 3'-00") Pipe included | \$1.00 per in. |
| WO | Cover Wood Pole any size-gather or flat (labor only) | \$0.50 per in. |
| WF | Cover Wood Finial any size | \$6.50 each |

| COVER WELT CORD | | |
|------------------------|---|------------------|
| Code | Description | Price |
| C1/2WC | Cover 1/2" Welt Cord (labor + material and running) | \$10.00 per yard |
| C3/4WC | Cover 3/4" Welt Cord (labor + material and running) | \$11.00 per yard |
| C1WC | Cover 1" Welt Cord (labor + material and running) | \$13.00 per yard |
| C2WC | Cover 2" Welt Cord (labor + material and running) | \$14.50 per yard |
| RN | Running Decorative Cords | \$3.00 per yard |

VALANCE (Continue)

| COVER WELT CORD with LIP | | |
|---------------------------------|---|------------------------|
| Code | Description | Price |
| 1/4WC | Make 1/4" Welt Cord (labor + material and sewed on) | \$8.00 per yard |
| 1/2WC | Make 1/2" Welt Cord (labor + material and sewed on) | \$10.00 per yard |
| 3/4WC | Make 3/4" Welt Cord (labor + material and sewed on) | \$11.00 per yard |
| 1WC | Make 1" Welt Cord (labor + material and sewed on) | \$13.00 per yard |
| 2WC | Make 2" Welt Cord (labor + material and sewed on) | \$14.00 per yard |
| SN | Sew on Decorative Cords with lips | \$5.00 per yard |

| COVER FOAM BALLS | | |
|-------------------------|---------------------------------|--------------|
| Code No. | Description | Price |
| 4FB | 4" Foam Ball (labor + material) | \$11.50 each |
| 6FB | 6" Foam Ball (labor + material) | \$12.50 each |

| LINING | | |
|-----------------|---|-----------------|
| Code No. | Description | Price |
| 48LI | 48" white or ivory regular lining | \$5.00 per yard |
| 54LI | 54" white or ivory regular lining | \$5.50 per yard |
| 48BOL | 48" Blackout lining | \$7.50 per yard |
| 54BOL | 54" Blackout lining | \$8.00 per yard |
| 48 TLI | 48" white or ivory Thermal suede lining | \$5.50 per yard |
| 54TLI | 54" white or ivory Thermal suede lining | \$6.00 per yard |
| 54ILI | 54" Inter-lining fabric | \$5.50 per yard |
| 54sli | 54" Sateen Plus (Inter-lining & Lining) | \$8.00 per yard |

| TWISTED OR BRAIDED WELT CORD | | |
|-------------------------------------|---|------------------|
| Code | Description | Price |
| TWC1 | Twisted 1/2" Welt Cord (labor + material) | \$19.50 per yard |
| TWC2 | Twisted 3/4" Welt Cord (labor + material) | \$21.00 per yard |
| BWC1 | Braided 1/2" Welt Cord (labor + material) | \$31.00 per yard |
| BWC2 | Braided 3/4" Welt Cord (labor + material) | \$33.00 per yard |
| RN | Running Welt Cords or Decorative Cord | \$3.00 per yard |

| VELCRO | | |
|---------------|--------------------|------------------|
| Code | Description | Price |
| SV | Single Velcro | \$7.00 per yard |
| DV | Double Velcro | \$10.00 per yard |

INSTALLATION PRICE LIST

| Code No. | Description | Price |
|-----------------|--|-----------------|
| 300 | Drape - Single Rod | \$.71 per in. |
| 301 | Drape - Double Rod | \$1.20per in. |
| 302 | Valances | \$.60 per in. |
| 303 | Sunburst up to 48" wide | \$33.50 each |
| 304 | Sunburst 55" and wider | \$49.50 each |
| 305 | Vertical Blind | \$14.00 each |
| 306 | Mini Blind | \$8.50 each |
| 3000 | Woven Wood | \$13.50 each |
| 307 | Making Template for Sunburst up to 48" wide | \$25.50 each |
| 308 | Making Template for Sunburst up to 55" and wider | \$33.50 each |
| 309 | Install Tie-Back | \$9.00 per pair |
| 310 | Trip Charge | \$69.00 |
| 311 | Trip Charge out of Houston Limit - maximum 15 miles radius | \$86.50 |
| 312 | Measure for Arch or Bay Window | \$33.00 |
| 313 | Measure for straight window | \$16.5 |
| 314 | Window higher than 12 feet | \$175 extra |
| 315 | Install Roman Shade | \$10.00/each |
| 316 | Cut Wood Rod | \$5.00/each |
| 317 | Cut Iron Rod | \$8.00/each |